

Lasers

The Power of Choice

The Power of Choice

With modern laser technology, nearly any manufacturing method can be realized with high quality and resource efficiency. When it comes to developing new products, you can rely on light to provide the right tool for your production environment! To ensure you get exactly the technology and support you need, TRUMPF offers a unique range of lasers and laser systems combined with global application consulting, integration support, and comprehensive after-sales service. Put simply, that's the Power of Choice.



How laser technology from TRUMPF is helping to shape the megatrends in production and society.

Industries and trends **4–7**

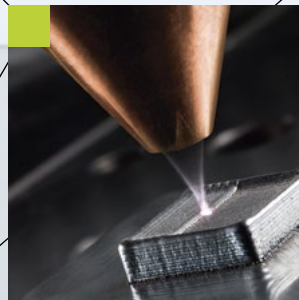

How to find out which laser technology offers the best solution for you.

Applications and technologies **8–9**



How TRUMPF can help you transform a product concept into a manufacturing process.

Know-how and support **10–11**

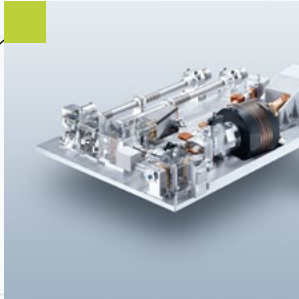

Learn more about the benefits of each type of laser in the TRUMPF product range.

Laser beam sources 12–29



How to kit out your laser with focusing optics and a sensor system to make your production process even simpler and more reliable.

Components 30–37



How TRUMPF lasers' interfaces and control options ensure smooth integration in your production environment.

Integration 38–39



How to get the right support from TRUMPF at the right time – and delve even deeper into the world of TRUMPF.

TruServices. Your Partner in Performance 40–41



Discover the wide variety of TRUMPF laser technologies in our film **"The Power of Choice"**: www.trumpf.info/fmpr6x



Your industry, our motivation

TRUMPF lasers are used in a wide variety of industries, from cutting micrometer-thin shapes out of display glass to welding centimeter-thick metal for wind turbines. As a key technology leader, TRUMPF is continuously investing in research and development for new technologies and potential future applications. The major trends shaping our society act as an incentive to seek even better solutions for your innovative, efficient, and high-quality production processes.



See the versatility that working with laser tools offers across all industries: www.trumpf.com/s/kecj9f

Mobility



We may not have reached the stage where our lasers can beam people from one place to another. Yet they have already proven their ability to support the mobility and logistical

requirements of our society. That includes making cars more efficient, trains lighter, aircraft safer, and ships more stable. Our lasers are also helping to shape frontline themes such as e-mobility.

– kg

Lightweight design with finely rendered laser weld seams leads to reduced fuel consumption and lower CO₂ emissions.

13.5 nm

is the wavelength of EUV light for microchip production – generated with the TRUMPF laser amplifier.

Communication

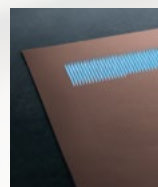

Effective communication is a must in today's smart world. Our lasers provide solutions for the key process at the heart of modern technical communication systems – chip manufacturing.

As part of Industry 4.0, TRUMPF is advancing digital connectivity in production with numerous solutions.

100 cm²/s

is the ablation rate of our short-pulse lasers, which facilitate the cost-effective production of thin-film solar modules.

Energy



Is saving energy a key priority for you and your industry, too? Our highly efficient lasers open the door to energy-efficient production and help make your components lighter and tougher. TRUMPF lasers offer solutions for more energy efficiency in the wind power and photovoltaic sectors, to mention just a few.

$1 \cdot 10^{-12}$ s

Stents made of nitinol or polymer cut by ultrashort pulse lasers exhibit a high-quality, smooth surface so that no deposits can build up. That helps arteries stay open over the long term.

Health

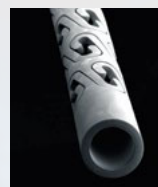

TRUMPF lasers are used in medical technology to create precisely rendered microstructures – and the results are already having a major impact on people's health and quality of life. TRUMPF is also working together with the Max Planck Institute to develop atto-second laser technology that could, in the future, be used to detect tumors as small as 1 mm.

Your needs, our support

Whether you already know exactly what you want or are looking for a tailor-made solution, we're at your side right from the word go. The laser is a unique tool – and we're passionate about the opportunities it offers. TRUMPF has Laser Application Centers (LACs) all over the world ready to cater to your needs. Because we believe you should always be able to find the right partner in the right place – with exactly the right technology to meet your needs.

Tap into TRUMPF as ...

... a project consultant

"We can provide you with advice and support from product conception through to production optimization. If the production process is defined in one of our LACs, then we can help you find an integrator if you need one. We'll work together with you to get the production process up and running, and then optimize it until you are completely satisfied with the results."

Antje Engler, System Support Manager, Plymouth Township



USA:
Farmington

Switzerland:
Grüsch & Baar

USA:
Plymouth



... a service partner

"We are on hand with our tailor-made service packages to help keep your business running smoothly. If something goes wrong, our comprehensive remote services can quickly get things back on track even before it comes to that – thanks to TRUMPF Condition Based Services. We also offer an extensive range of on-site training programs, functional enhancements, and application services."

Benjamin Blocksdorf, Head of Sales Services Global, Ditzingen



... a technology developer

"We've been developing lasers at TRUMPF for more than 40 years. Time and again we have transformed visions into reality with the help of our research partners. And now you can use this extraordinary know-how to gain a competitive edge. Take our innovative ultrashort pulse lasers, for example. My project partners and I received the 2013 "Deutscher Zukunftspreis" (German Future Prize) for our work in this field – and it has already yielded a wealth of successful applications."



Dirk Sutter, Head of Development Group for Ultrashort Pulse Lasers, Schramberg



Find out more about how we can assist you with our Laser Application Centers here:
www.trumpf.com/s/7smpvy



... an industry sector manager

"We take a unique industry sector approach that offers you support long before you start using our lasers on your production line. Our expert team already provides help during your development for industries such as the automobile industry and consumer electronics. We work together with you to exploit the full potential of laser technology and develop tailor-made solutions in your production. For example, in the automotive industry, lasers are used for machining high-strength materials, to realize laser brazing of components and in the consumer electronics industry for display technologies."

Marc Kirchhoff, Head of Industry and Global Key Account Management, Ditzingen

... an applications specialist

"Laser microprocessing is currently making its way into the world of production, with more and more customers taking notice of our wide range of ultrashort pulse lasers. My team and I are by your side to provide optimal cost-effective process solutions, from the feasibility study all the way to commissioning. To support our customers, we rely on our broad capability comprising application consultants, highly qualified application specialists, my many years of experience in the development of laser production systems, and a far-reaching network of globally active integrators."

Christoph Neugebauer, Micro Service and Support Group Leader, Ditzingen

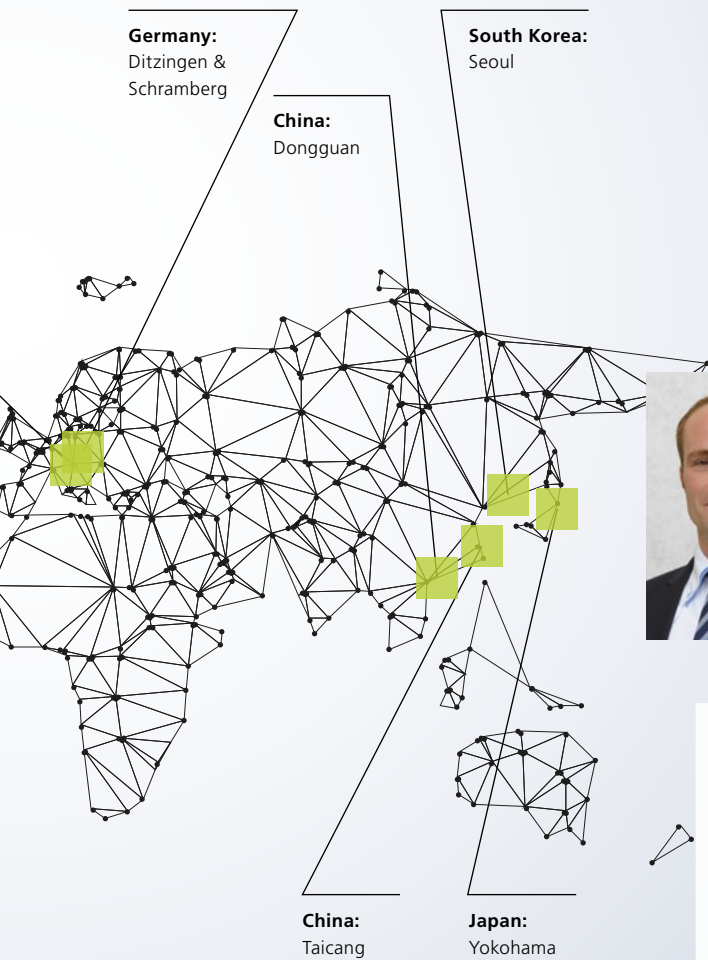

Your production, our portfolio

Solid-state lasers



**TruDisk
14-17**



**TruDisk
green
18-19**



**TruFiber
20-21**

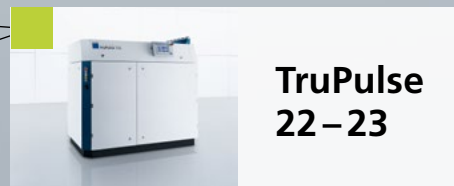

**TruPulse
22-23**

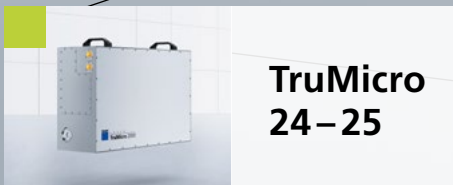

**TruMicro
24-25**

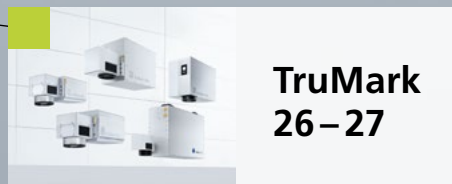

**TruMark
26-27**

CO₂ lasers



**TruFlow
28-29**

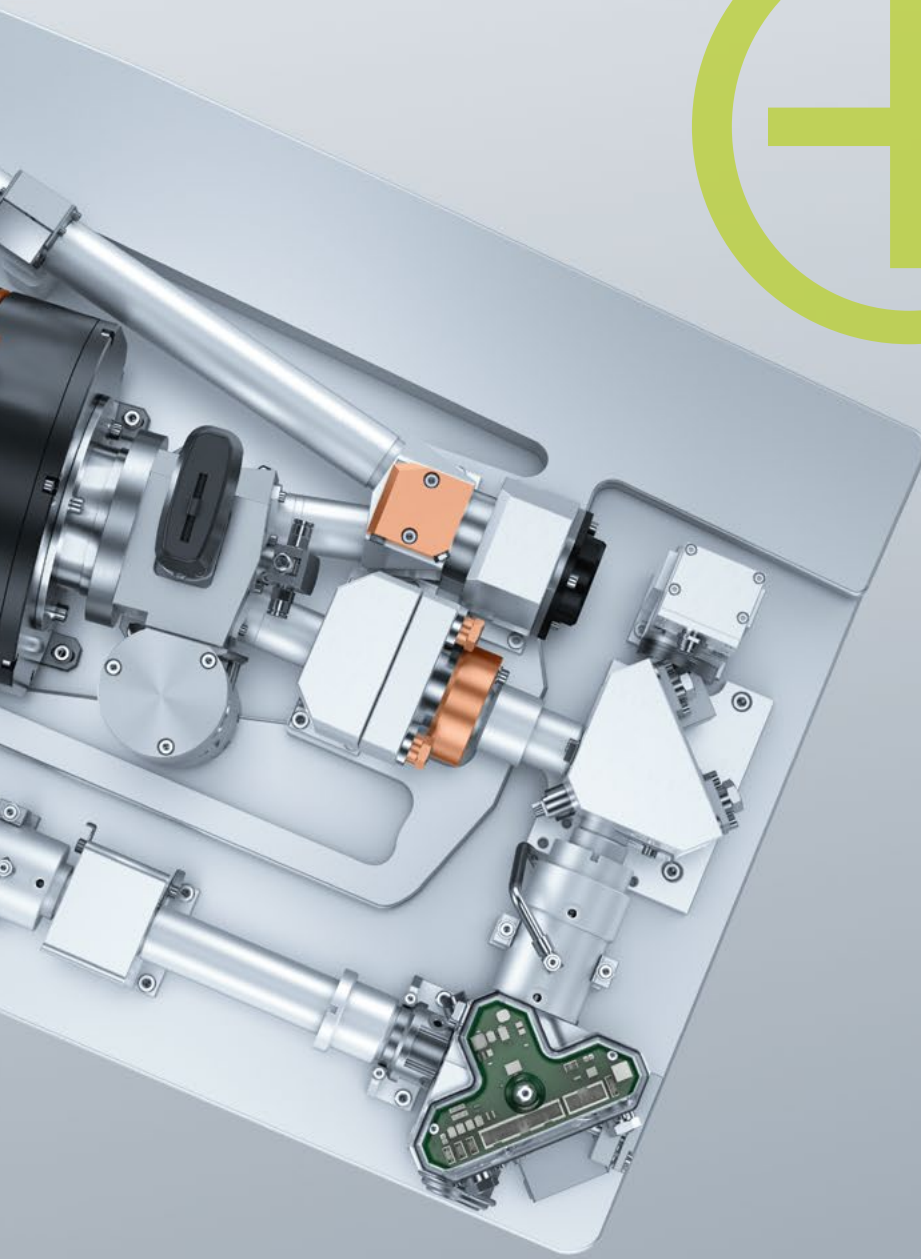

Why choose TRUMPF lasers?

- 1 Innovative solutions
- 2 Highest precision and quality
- 3 Comprehensive portfolio
- 4 Global application consulting
- 5 Long-standing experience
- 6 Industry experts
- 7 High level of availability (Remote Services)
- 8 On-site service
- 9 Customized services
- 10 Industry 4.0 ready

| | TruDisk | TruDisk green | TruFiber | TruPulse | TruMicro | TruMark | TruFlow |
|------------------------|---------|---------------|----------|----------|----------|---------|---------|
| Welding | ■ | ■ | ■ | | | | ■ |
| Precision welding | ■ | ■ | ■ | ■ | | | |
| Laser metal deposition | ■ | | | | | | |
| Brazing | ■ | | | | | | |
| Cutting | ■ | ■ | ■ | | | | ■ |
| Precision cutting | ■ | ■ | ■ | | ■ | | |
| Drilling and ablation | | ■ | | ■ | ■ | ■ | |
| Hardening | ■ | | | | | | |
| Additive manufacturing | ■ | | ■ | | | | |
| Marking | | | | | ■ | ■ | |

TruDisk

01

Maximum beam quality

thanks to disk technology

02

Optimized for Industry 4.0

with intelligent hardware

03

Ultracompact and easy to maintain

thanks to its modular design

04

Flexible cooling concept

Supply temperature of up to 38°C
with integrated cooler



The TruDisk disk laser provides you with immense power combined with maximum beam quality for manufacturing. It is the ideal partner for high-speed cutting, welding, and surface processing.

08

Integrated beam guidance

for maximum utilization of the laser

07

Always reproducible results

thanks to 100% constant power and the patented resonator design

06

Almost spatter-free welding

with BrightLine Weld

05

Save energy

thanks to the high level of operating efficiency and intelligent pulse function



Find out more about the benefits and applications of the disk laser here:
www.trumpf.com/s/sik0v2

01

Maximum beam quality

thanks to disk technology

Using a disk as a laser medium ensures brilliant beam quality – as low as 2 mm-mrad with TruDisk lasers. With a power spectrum of 1 kW to 16 kW, you can achieve optimal results in a wide range of processes, from laser welding and cutting to laser metal deposition, hardening, and generating of 3D parts.



With the disk geometry, maximum power and beam quality are not mutually exclusive.

02

Optimized for Industry 4.0

with intelligent hardware

The TruDisk is the ideal interface for your smart production: It is capable of synchronized data recording from all sensors and provides high-quality information for virtual analysis. This can be read out via the OPC UA interface on the laser. The laser thus creates the ideal hardware conditions for services such as condition monitoring and predictive maintenance.



The TruDisk provides everything needed for smart production.

03

Ultracompact and easy to maintain

thanks to its modular design

There is nothing smaller: Save space with an installation surface of less than 1 m² – including the cooling system! The modular design of the TruDisk also makes it extremely easy to service – individual components can be replaced quickly and easily. This saves time and increases machine availability.



Robust and modular optical design of the TruDisk.

04

Flexible cooling concept

Supply temperature of up to 38°C with integrated cooler

The TruDisk uses a flexible cooling concept. You can choose between the standard variant with integrated heat exchanger and the optional integrated compressor cooler depending on the temperature of your water supply. This does not change the compact installation space of the laser. If a cooling water supply is available, you can forget using an external cooling unit entirely.

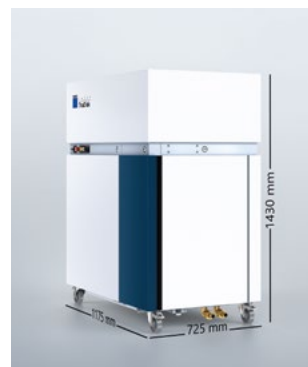

TruDisk with integrated heat exchanger.

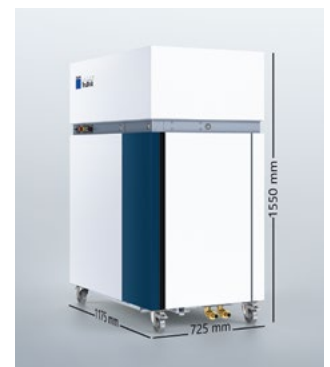

TruDisk with integrated compressor cooler.

05

Save energy

thanks to the high level of operating efficiency and intelligent pulse function

Enjoy the benefits of a high level of operating efficiency and an efficient pulse function. This enables the diode current of the disk laser to be reduced to 0 A, even during extremely short pauses in work. For longer processing breaks, the intelligent energy management of the TruDisk laser ensures consistent energy efficiency in operation – both during laser-on times and laser-off times.

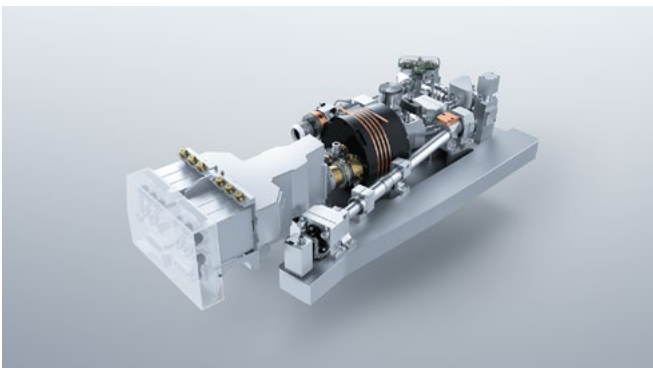

The diode current switches off completely, even during extremely short processing breaks in work. This saves you unnecessary energy costs.

06

Almost spatter-free welding

with BrightLine Weld

Whether copper, steel or aluminum – with BrightLine Weld, welding is almost spatter-free and has the highest quality. The minimum spatter reduces dirt build-up on components, clamping fixtures and optics. With BrightLine Weld the feed rate is simultaneously increased, thereby significantly increasing the productivity. Your components need less finishing work, and you benefit from low machine downtimes and less frequent changes of the protective glass.

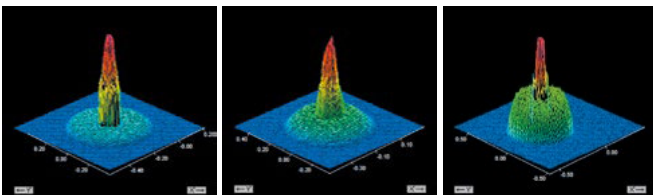

Flexible setting of the intensity distribution with BrightLine Weld.

07

Always reproducible results

thanks to 100% constant power and the patented resonator design

With the TruDisk, you can benefit from the highest power stability available on the market – throughout the entire service life of your laser. When using the TruDisk, you can expect 100% constant power right from the first millisecond. Thanks to its patented resonator design, the TruDisk can easily handle even strong back-reflections. This enables you to process even highly reflective materials such as copper and other nonferrous metals without compromises.

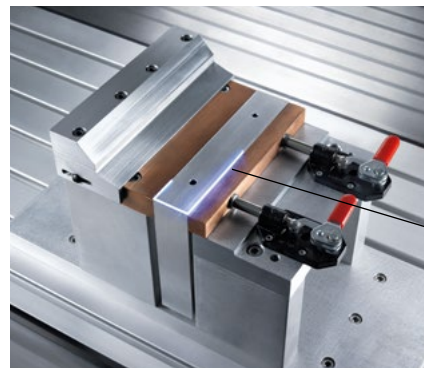

Can-cap welding with optimal precision.

08

Integrated beam guidance

for maximum utilization of the laser

The new generation of the TruDisks with up to 4 laser outputs can be perfectly adapted to your system concept. Beam guidance is integrated into the compact laser housing. Using several laser outputs enables you to increase the utilization of the laser, reduce part costs and boost system availability.

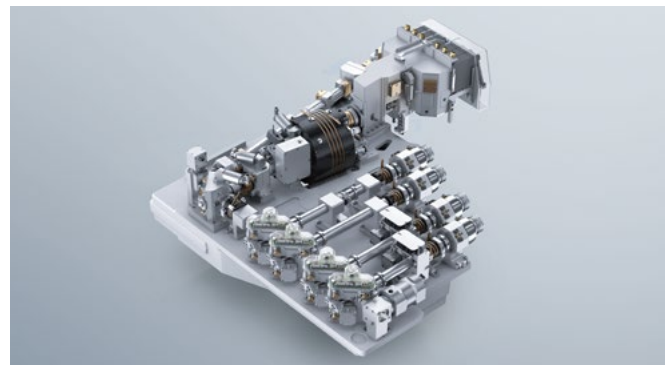

Optics setup of the new generation TruDisk with up to 4 outputs.

TruDisk with green wavelength

High quality and maximum reproducibility

01

High quality for copper processing

with green wavelength

04

Robust, reliable and industrial suitability

thanks to proven disk technology



02

Minimal spatter

thanks to uniform heating

03

Ideal for all surfaces

whether oxidized, sandblasted, etched or highly polished

01

High quality for copper processing

with green wavelength

Green light is better absorbed than infrared light when processing highly reflective materials such as copper. The improved absorption of green light generally leads to a much better input of the laser power to the workpiece. With TruDisk lasers with a green wavelength, you can choose between pulsed or CW mode as best suits your application. In both cases, you benefit from fast, highly efficient welding processes through the combination of green wavelength and high output power. Thanks to the extremely low scattered radiation produced by these pulses, you can almost always work without additional shielding for temperature-sensitive electronic components.

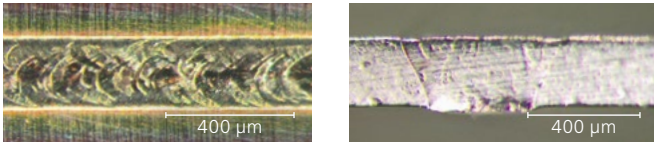

TruDisk 1020: Heat conduction welding of copper foil with $v = 10$ m/min, weld bead and cross-section.

02

Minimal spatter

thanks to uniform heating

The optimal input coupling of the green laser beam ensures smooth weld pool dynamics. Because of this, the TruDisk laser is perfectly suited for both heat conduction welding and high-quality deep penetration welding of copper. The material is heated evenly, and you can consistently achieve a reproducible, almost spatter-free process with a wider tolerance range. This enables you to prevent expensive reject parts or even undetected faults in components as well as short circuits. In deep penetration welding, the lasers can produce a reproducible and constant welding depth.



Welding of copper contacts on DCB substrate with well controlled welding depth using TruDisk 1020.

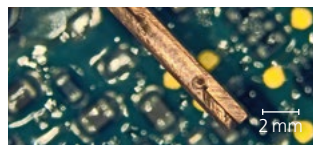

Welding of electronic components with minimum spatter formation thanks to green wavelength.



Welding of battery foil stacks consisting of 100 copper foils with TruDisk 2021. Left: Regular seam surface without ejections. Right: Cross-section of the poreless weld seam with large joint area.



03

Ideal for all surfaces

whether oxidized, sandblasted, etched or highly polished

With the green TruDisk lasers, you always achieve the same high level of quality in your welding results without needing to carry out readjustments, for various copper surfaces: oxidized, sand-blasted, etched or highly polished. The smooth process using green light ensures that you produce very robust copper welds of consistently high quality. You can even work without any expensive upstream surface treatment processing such as sand blasting or tinning.

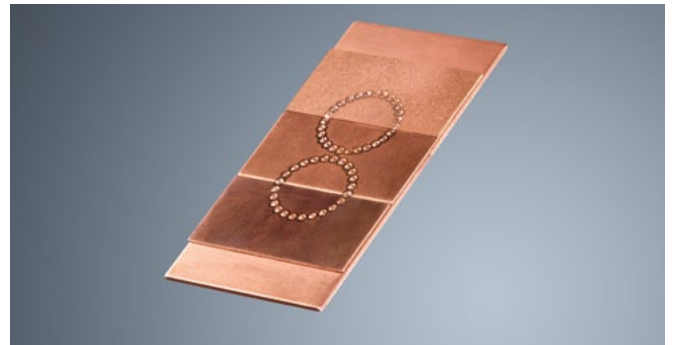

Expect the best results on any copper surfaces.

04

Robust, reliable and industrial suitability

thanks to proven disk technology

When it comes to robustness, reliability, and industrial suitability, put your trust in the TruDisk lasers. TRUMPF can offer you a unique complete package: laser, laser light cable, focusing optics and a sensor system – developed and tested for the green wavelength. Thanks to their excellent beam quality, TruDisk lasers are ideal for highly productive scanner applications.

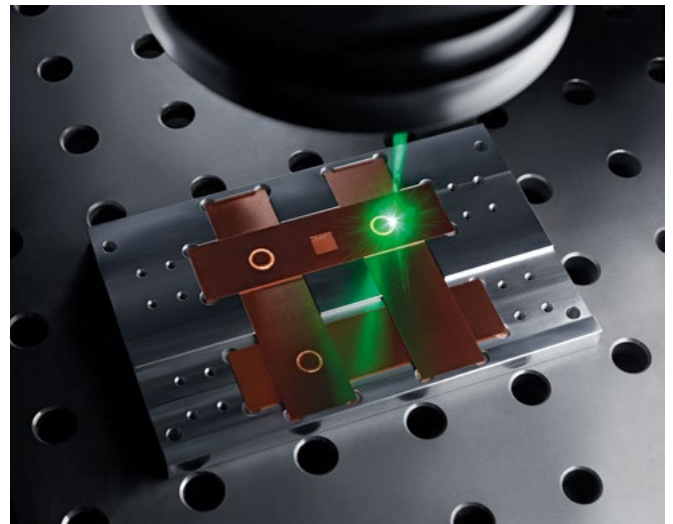

Using TruDisk with green wavelength enables to weld copper with superb stability and minimal spatter.

TruFiber

TruFiber boasts a small footprint and excellent beam quality.

01

Comprehensive solution from a single source

for easy integration

04

A compact power pack

easy to integrate



02

100% constant process results

for most demanding quality expectations

03

Optimized for Industry 4.0

as a future-ready platform

01

Comprehensive solution from a single source

for easy integration

At TRUMPF, lasers, control, beam guidance, processing optics and sensor systems are optimally coordinated to each other. This also applies to the TruFiber, for example, in conjunction with the programmable focusing optics (PFO). The VisionLine image processing system detects characteristics on components and ensures that welding always happens in the right place. Furthermore, CalibrationLine checks the focus position and laser power at regular intervals.

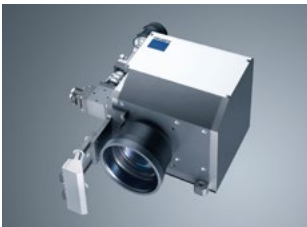

The programmable focusing optics (PFO) can be set up quickly and has the right configuration for all machining processes.

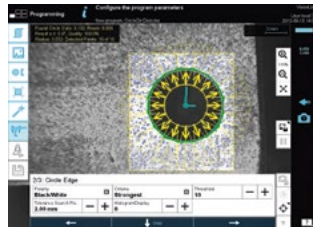

VisionLine image processing is used to avoid defective parts.

02

100% constant process results

for most demanding quality expectations

With its particularly robust design concept, the TruFiber withstands disturbance factors and external stress and strain. The integrated laser power control measures and regulates the laser power in real time to $\pm 1\%$ accuracy. The TruFiber has comprehensive mechanisms for protecting the laser against back-reflections.

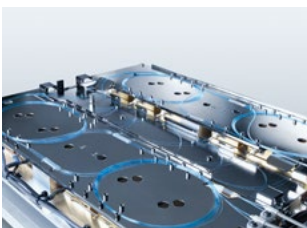

A dehumidification unit is optionally available for use in tropical regions.



The integrated laser power control measures and regulates the laser power precisely and steadily to the nearest $\pm 1\%$, regardless of the surrounding conditions.

03

Optimized for Industry 4.0

as a future-ready platform

With the TruFiber you can take a big step towards your Smart Factory. Due to the laser's connectivity via OPC-UA, optimum networking of the fiber laser is guaranteed. Using Factory Gate you can integrate several devices into the network. With TRUMPF Condition Monitoring you also have full transparency at all times concerning all laser states via dashboards. The precision time protocol ensures precisely timed coordination of all sensors, and remote access ensures convenient service from anywhere.

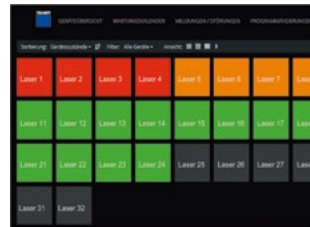

Analyse and control your production processes with a remote connection to the laser using secure IT technology, TRUMPF Condition Monitoring, predictive maintenance, quality data storage and dashboards for visualizing data.

>

PL

The Performance Level measures the reliability of the safety function in accordance with EN 13849.

e

Top safety class.

The TruFiber's high level of safety is an invaluable feature. With Performance Level e, the switching off/on times of the safety circuit EMERGENCY SHUTDOWN are guaranteed to be as low as 25 ms and 90 ms respectively.

04

A compact power pack

easy to integrate

Our TruFiber P compact Series belong to TRUMPF's compact category of CW lasers and are available in a handy 19-inch rack format with laser powers of up to 2 kW. Machine and system engineers are responsible for the operational safety of these laser systems.



Are you interested? You can find out everything else about the TRUMPF fiber laser here: www.trumpf.com/s/nto43r

TruPulse

Pulsed solid-state lasers emit short, powerful bursts of light. That makes them perfect for spot and seam welding as well as cutting.

05

Short pulses with great variability

due to different waveforms



04

Innovative technology

with flexible control of the pulse width and peak power

06

Broad application spectrum

for a great variety of applications



01

100% constant power

keeps your processes stable

02

High-precision 10 μ s pulses

get the job done where others fail

03

Versatile and easy to maintain

thanks to its modular design

01

100% constant power

keeps your processes stable

Real-time laser power control ensures that the output power reaching the workpiece matches your settings perfectly. The result: stable processes and reproducible results. This applies to the entire service life of your laser – regardless of the surrounding conditions. And that makes the TruPulse the perfect tool for even the trickiest applications.

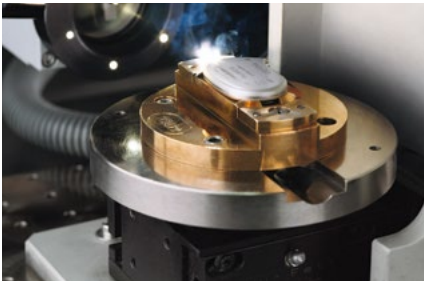

Stable process parameters are a must when it comes to creating nonporous, helium-tight weld seams in pacemakers.

02

High-precision 10 µs pulses

get the job done where others fail

With a pulse rate of 10 µs, the laser can closely match the actual pulse shape to the desired pulse shape. That means you always get the graphically programmed shape combined with superior pulse-to-pulse stability. A pulse power of several kilowatts for a few milliseconds makes welding and cutting possible in situations where other methods fail.

03

Versatile and easy to maintain

thanks to its modular design

With the TruPulse you benefit from a wide product portfolio. Thanks to the modular design, all its components can be repaired or replaced on site should the need arise. Equipped with up to six laser outputs, the versatile TruPulse can serve one or more processing stations at a time through energy- or time-sharing configurations.

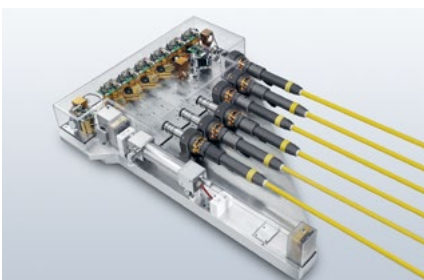

Thanks to their modular optical design, TruPulse lasers can be adapted to each and every requirement.

04

Innovative technology

with flexible control of the pulse width and peak power

The TruPulse nano laser is based on state-of-the-art fiber laser technology offering power levels of 20 to several 100 W. It offers integrators and users highly flexible control of both pulse width and peak power. The unique PulseTune function enables market-leading pulse repetition frequencies combined with simultaneous maintenance of peak power.

05

Short pulses with great variability

due to different waveforms

Featuring up to 48 preprogrammed waveforms offering pulses in the range of single-digit nanoseconds to microseconds. This enables pulse parameters to be perfectly optimized for individual applications, which in turn raises process quality and productivity.

06

Broad application spectrum

for a great variety of applications

TruPulse nano lasers use a range of beam qualities, developed to maximize performance for a diverse range of applications: from patented welding techniques for dissimilar metals to drilling and microcutting to marking, engraving and cleaning – our short-pulse lasers provide the right parameters across the board. These pulsed fiber lasers operate maintenance-free, enabling you to concentrate on the result, making time-consuming maintenance plans a thing of the past.



A great variety of products can be welded, regardless of their material, thickness or the combination of different metals. With the short-pulse welding process, combinations of thin metal parts can be joined. This also includes highly reflective and conductive metals – perfect for applications such as battery welding.



Visit our website if you would like to know more about the TruPulse:
www.trumpf.com/s/ky11nq

TruMicro

Short and ultrashort laser pulses enable precise high-speed machining in all industrial sectors.

01

Intelligent laser control

with power modulator accurate to a single pulse

05

Customized pulses

pulse duration, energy and wavelength for specific applications



02

Minimal heat input

thanks to high peak pulse power of ultrashort laser pulses

04

Complete flexibility

at all wavelengths and pulse durations

03

Easy integration

into any production environment

01

Intelligent laser control

with power modulator accurate to a single pulse

Simply smart: The ultraquick power modulator maintains the power and pulse energy at exactly the required level, regardless of external factors. With pulse picking, adjustment of the repetition rate with single-pulse precision (pulse on demand) and pulse-specific control of pulse trains (burst), pulse energy, and pulse intensity you always have the pulse you need. For ideal results at complex tasks – around the clock in industrial use.

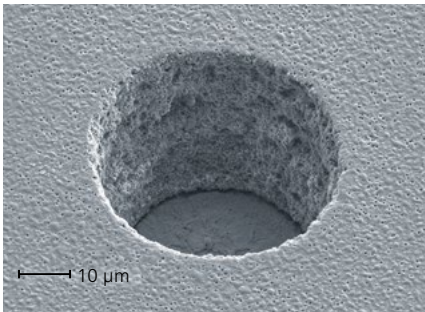

The high peak pulse power of the short and ultrashort pulse lasers are capable of drilling precise holes in delicate materials.

02

Minimal heat input

thanks to high peak pulse power of ultrashort laser pulses

With pico- and femtosecond pulses, the intensities are so high that the material is directly ionized. Precise processing without undesired heat influence is the result – this is known as cold material removal. Even delicate materials can be processed reliably. Whether semiconductors, metals, plastics or brittle-hard materials: spatter, cracks and material bulging are a thing of the past.

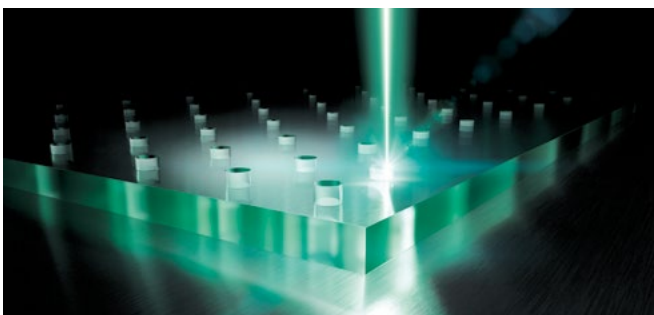

Microdrillings with diameters of 80 μm in 0.1 mm thick glass. Precise holes of this type are generated by ultrashort laser pulses and are used, for example, to create connections between circuit layers in electronic components that are separated by a glass layer (so-called through glass vias).

03

Easy integration

into any production environment

TruMicro lasers are inherently integration-friendly and have numerous interfaces that facilitate integration into your production system. The fieldbus interfaces include Profibus, EtherCat and DeviceNet, so that your TruMicro is easily compatible with all standardized protocols. Standardized software interfaces (OPC UA) enable communication between laser and production system.

04

Complete flexibility

at all wavelengths and pulse durations

Use the TruMicro short and ultrashort pulse lasers to get complete flexibility at your factory: Any pulse frequency for the TruMicro 2000 can be chosen using the linear amplifier regardless of the pulse energy used. The laser can be mounted horizontally or vertically and does not need a pump light cable. Furthermore, you can adjust the pulse duration almost infinitely to find the perfect parameter for your application. With the TruMicro Series 5000 you are working with infrared, green or ultraviolet light, either using picosecond or femtosecond pulses.



The TruMicro Serie 5000 offers the best parameters for your process. Choose a suitable combination from a variety of pulse durations, pulse energies and wavelengths.

05

Customized pulses

pulse duration, energy and wavelength for specific applications

Power and pulse energy – the pulses can be adapted to your requirements, for example, to achieve maximum stability through our patented quadruple monitoring of the beam source – with the pulse energy monitored for each individual pulse. The power can be regulated from 2 to 100%, even during the process.



You can find everything you need to know about the TRUMPF short and ultrashort pulse lasers here:
www.trumpf.com/s/ultrashortpulsedlasers

TruMark

TruMark lasers make it faster and easier than ever to achieve perfect marking results. They can create customized, permanent, high-quality markings on virtually any material.

01

The freedom to choose

in every way

04

Immediate quality control

thanks to image processing



02

Easy integration and automation

thanks to a broad range of functions

03

Intuitive operation

thanks to innovative solutions

01

The freedom to choose

in every way

You have access to the ideal solution for every power class – regardless of material, machining speed, wavelength and component geometries you wish to use. Depending on the application, fiber lasers with high average power, rod lasers with high peak pulse power or ultrashort pulse lasers are used. You can also use TruMark lasers for machining or cleaning surfaces, for example in order to prepare surfaces for welding or adhesive application or for optimizing tribological characteristics.



The TruMark 5010 is a compact, all-in-one solution.

02

Easy integration and automation

thanks to a broad range of functions

Whether you're looking to integrate a laser into your production line or install a laser workstation in a stand-alone capacity, TruMark offers you everything you need. Simply choose the optimum solution for your manufacturing environment from a wide range of models, interfaces, and software options – from batch size one to mass production. We're always on hand to give you the advice you need.



Interface diversity for easy integration.

03

Intuitive operation

thanks to innovative solutions

TruMark lasers are easy, safe and quick to use, even for less experienced operators. This is ensured by intuitive operating software and innovative solutions for setting up processes such as the pilot laser, the focus finder, the navigator or image processing solutions for automatic positioning of markings on the workpiece. These enable you to productively, flexibly, and cost-effectively create first-class markings.



Data Matrix Code (DMC) and clear text for permanent traceability in batch production.

04

Immediate quality control

thanks to image processing

Always on the safe side: With the VisionLine image processing package, the laser markings are positioned perfectly and the laser focus is found automatically. Codes are read out, evaluated and documented immediately after marking. Even the smallest DMC modules of less than 200 µm can be read out quickly and with exceptional resolution thanks to the shortened exposure times. With the TruTops Mark Module Interface (TTM-MI), you also have the convenience of being able to establish a connection to your database and directly retrieve data and writing it back again.

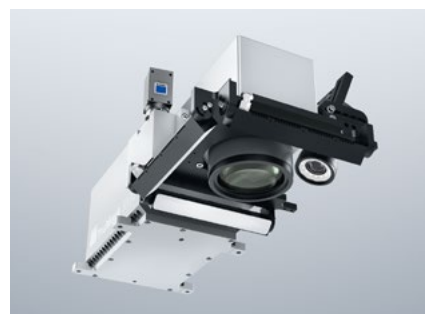

VisionLine uses image processing to check the quality of the marking.



Everything you want to know about laser marking:
www.trumpf.com/s/markinglasers

TruFlow

Reliable and robust: CO₂ flow lasers offer an all-round solution for cutting and welding a wide range of materials.

01

Maximum stability

thanks to its compact, square design

05

Reliable laser operation

thanks to continuous monitoring of the mirror

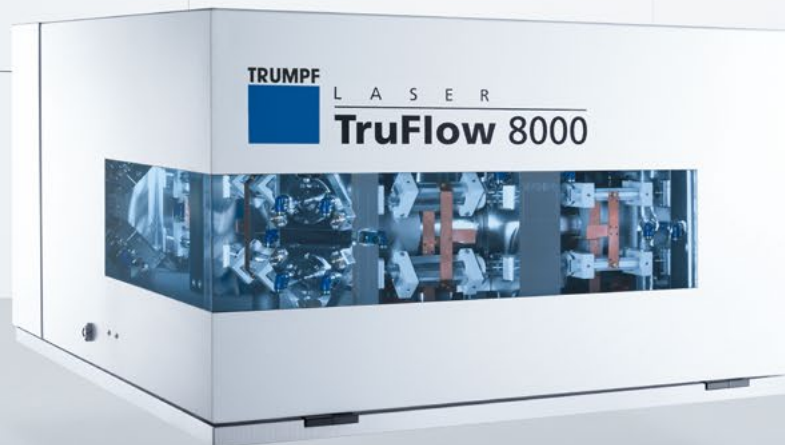

02

20% energy savings

thanks to cooling concept and energy management

04

Integrated beam guidance

for perfectly aligned laser light

03

Minimal wear

thanks to superior technology

01

Maximum stability

thanks to its compact, square design

Every TruFlow resonator undergoes its basic lifetime calibration in the clean room. The resonator's key components are water-cooled, and its square design makes the resonator extremely robust. It is not affected by changes in temperature. All of the parameters remain constant even at high laser powers – and no other system can match the stability of the TruFlow's beam output angle.



The stable resonator can even be installed on moving gantries.

02

20% energy savings

thanks to cooling and energy management concepts

The new and improved cooling system in your TruFlow reduces energy consumption by up to 20% and makes the TRUMPF CO₂ laser one of the most energy-efficient machines in its class. This is boosted even further by the TruFlow's intelligent energy management system.

03

Minimal wear

thanks to superior technology

TruFlow uses a wear-free system of gas circulation and radio-frequency excitation. The magnetically suspended turbo blowers ensure that no damage is caused by power outages or emergency shutdowns. Take advantage of the decades of development that have gone into this all-round laser machining solution.

04

Integrated beam guidance

for perfectly aligned laser light

The fully encapsulated built-in beam guidance system that comes with your TruFlow prevents any accumulation of dirt that could cause the laser power to drop and the focus geometry to fluctuate. Additional components for beam expansion, pilot laser and circular polarizer are stowed safely and compactly under the laser hood.

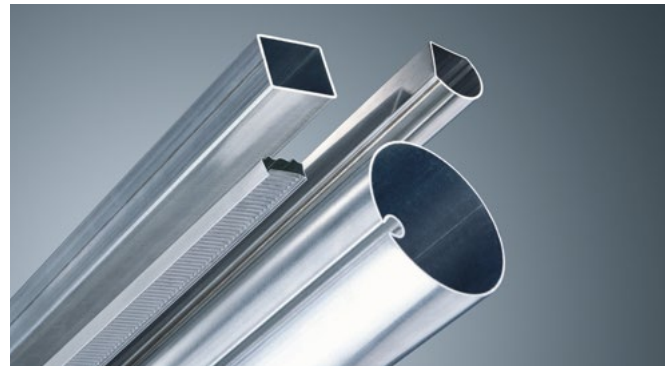

Laser tube welding is also possible thanks to optimized beam guidance and beam shaping.

05

Reliable laser operation

thanks to continuous monitoring of the mirror

The output mirror is one of the most highly stressed components of your laser. That's why the TruFlow continuously monitors the mirror to check its temperature and detect any contamination. That keeps your laser working smoothly.



A truck axle welded with a CO₂ laser.



You can find more information on the TruFlow here:
www.trumpf.com/s/1yiwem

Programmable focusing optics (PFO)

The key to successful production.

01

Top productivity

thanks to reduced nonproductive time

05

Intuitive operation

thanks to smart software solutions

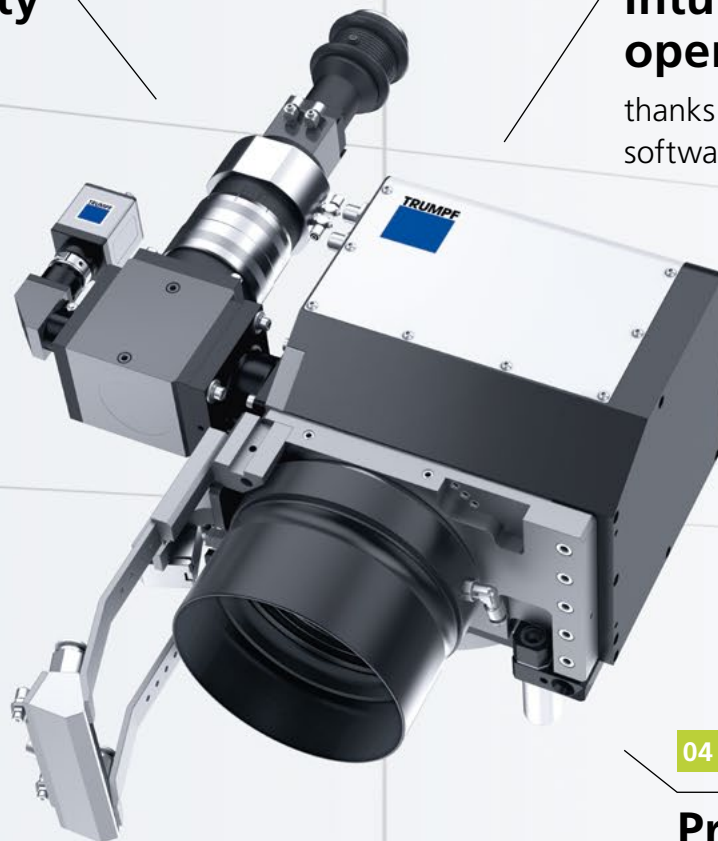

04

Process reliability

thanks to flexible integration of sensor systems

02

A broad choice

for any application

03

On-the-fly capabilities

thanks to real-time synchronization of the PFO and robots

01

Top productivity

thanks to reduced nonproductive time

The PFO positions the laser beam in the processing field precisely and highly dynamically. Contrary to conventional laser welding, welding with the PFO does not require the workpiece or the focusing optics to be moved. This reduces nonproductive time and increases your productivity.

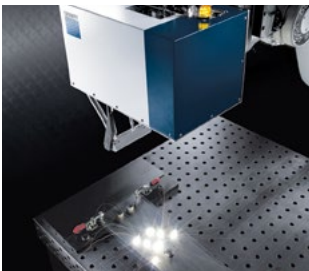

Remote welding with the programmable focusing optics PFO 3D.

02

A broad choice

for any application

Whether for plastic welding, for spot welding of electronic contacts or for remote welding of bodywork parts – the PFO Series can offer perfect focusing optics for your application. Choose between the 1D scanner optics PFO 1D, the 2D scanner optics PFO 20 or PFO 33, and 3D scanner optics PFO 3D depending on the component and welding job. A number of collimation and focal lengths are available to ensure the optimum configuration for your application.



Welding of aluminum battery cases.

03

On-the-fly capabilities

thanks to real-time synchronization of the PFO and robots

Combining PFO and robots also enables on-the-fly processing of complex three-dimensional components. Intelligent, real-time synchronization of the robot, laser and PFO ensures precise positioning of the laser beam without additional programming effort even at different robot speeds – that's welding on-the-fly at its best!



I-PFO: Intelligent processing on-the-fly.

04

Process reliability

thanks to flexible integration of sensor systems

The programmable focusing optics are available fitted with interfaces for TRUMPF sensor solutions such as CalibrationLine and VisionLine. CalibrationLine calibrates the beam position and laser power on the workpiece, while VisionLine detects the position of the workpiece and corrects the beam trajectory. The flexible design of the PFO furthermore enables the use of camera systems for edge detection and seam tracking, pyrometers for temperature control, as well as use of external process sensor systems.

05

Intuitive operation

thanks to smart software solutions

The PFO SmartTeach app enables you to intuitively and extremely quickly adjust laser programs, even while on the move. The camera mounted on the PFO transmits a live image directly to the app, and the app synchronizes your new programs directly with the laser. The offline software TruTops PFO enables you to easily program welding geometries and various wobbling methods. In addition, TruTops I-PFO ensures processing at an optimized cycle time.

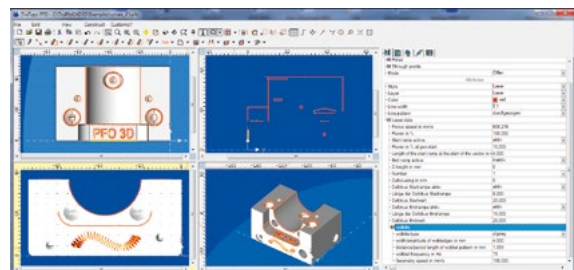

Programming of welding geometries with TruTops PFO.



Continue reading here if you would like more information on programmable focusing optics: www.trumpf.com/s/bvunme

Focusing optics

The modular system of the TRUMPF focusing optics is suitable for any process, whether welding, cutting or surface treatment.

01

The right optics

for your process

05

Easy to integrate

in your production line



02

Perfect weld seams

thanks to clever process gas management

03

Robust and reliable

in everyday industrial settings

04

Intelligent monitoring

and all parameters at a glance

01

The right optics

for your process

Whether for high output power of over 16 kW or for a focus diameter of just 10 μm – you can be sure of getting optimum results with the right optics. The TRUMPF portfolio consists of the modular BEO Series, the CFO Series with a number of monitoring functions and the reflective focusing optics RFO for the highest laser power. TRUMPF also offers special optics for deposition welding with powder feed and for linear laser spots.

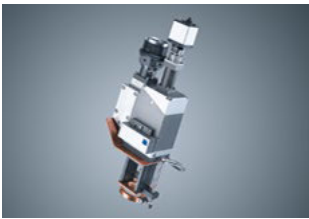

Reflective focusing optics RFO for welding at the highest laser power from 16 kW.

02

Perfect weld seams

thanks to clever process gas management

The combination of top-quality lenses and protective glass monitoring ensures minimal focus shift and homogeneous welding results. Crossjet airflow also protects the lenses from contamination, while the patented metal vapor effect nozzle produces more stable welds. The shielding gas supply can be adapted in different ways to reduce the oxide film on the weld seam.



BEO D70 with crossjet and shielding gas supply.

03

Robust and reliable

in everyday industrial settings

The TRUMPF focusing optics have proven their industrial suitability in the widest range of applications over many years. They offer a compact and robust design. Optional components such as the crossjet and the cartridge module ensure the highest level of protection of the lenses from contamination and resulting in a long service life for the optics. The coordination between the laser device, the laser light cable and the optics achieved during development guarantees high-quality process results.

04

Intelligent monitoring

and all parameters at a glance

The optics of the CFO Series makes monitoring the focusing optics easy. Operating values such as protective glass contamination, crossjet gas, shielding gas and cooling water can be easily monitored in the laser control system. The optional power measuring cartridge can be used to measure the laser power close to the process. Depending on the type of optics, other additional functions for process monitoring such as cameras systems can be attached.



Controlled focusing optics CFO.

05

Easy to integrate

in your production line

The modular system (for example 0° or with 90° deflection) and the optional components make several structural designs possible. The compact design of the optics makes it possible to weld in difficult-to-reach locations. Moreover, it saves on resources thanks to its light weight. Mechanical adapters ensure that the focusing optics can be used both in machine as well as robot applications.



The compact and powerful 90° version of the BEO D50.



You can find more information on the focusing optics from TRUMPF here: www.trumpf.com/s/typz8

01

Precise tracking

with seam position control
and monitoring

02

**Improved process
capability**

thanks to image processing
and OCT

03

More good parts

with welding depth monitoring

04

High-quality weld seams

thanks to temperature control

05

Controlled meltdown

via melt travel monitoring

06

**High repetition
accuracy**

with automatic focus and
power calibration

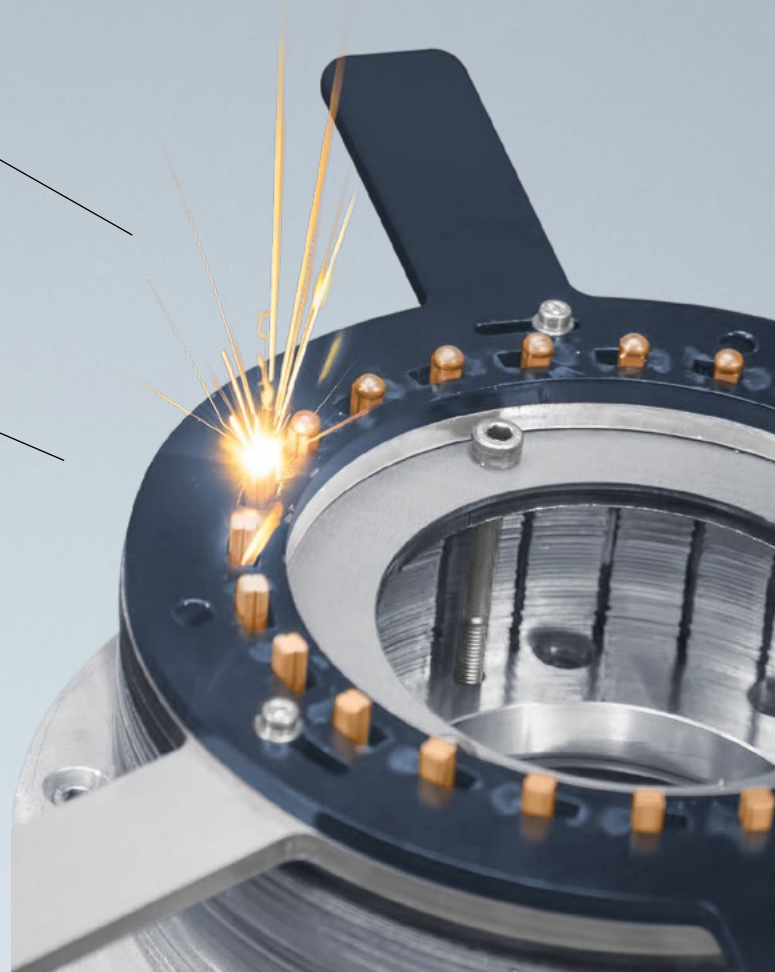

Sensor system

Trust your process with TRUMPF process sensors.

Stable processes are required for effective laser production. For this reason, our sensors monitor or even control the processes. This enables you to work with greater process reliability and save time.

01

Precise tracking

with seam position control and monitoring

Produce faster than ever before: the seam position control constantly keeps track of the joining point during welding and always positions the laser beam correctly for maximum process speed. This ensures that you are ideally equipped for processes such as continuous tube welding, joining transmission components or laser remote welding for bodywork construction. Online monitoring of the weld seam provides you with an additional benefit in terms of quality assurance.

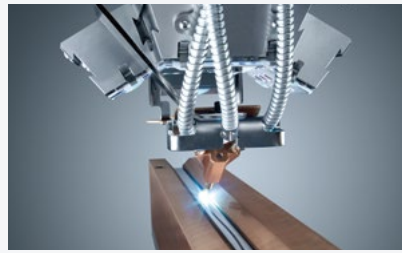

The seam position control enables you to keep reject parts to a minimum, for instance when welding tubes and profiles.

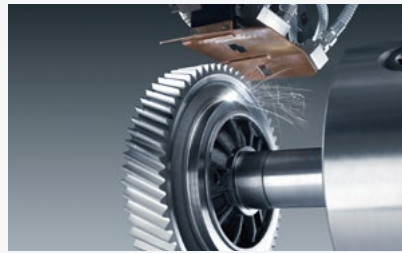

Additional autonomous x- and z-axes are integrated in the highly precise seam position control system for welding transmission components.

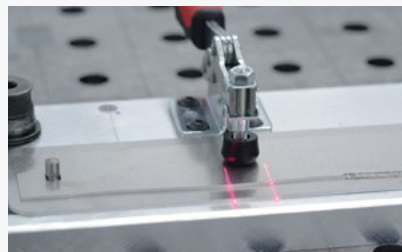

Laser remote welding: The seam position control system enables you to weld precise fillet seams, even in small flanges.

02

Improved process capability

thanks to image processing and OCT

You can keep track of your processes with VisionLine, our camera-based image processing feature. It detects the attributes of parts and ensures that welding or marking is done at the right place. VisionLine reads the code and lettering right after marking and evaluates the marking quality. VisionLine OCT Detect unites the world of incident light image processing and optical coherence tomography (OCT). The image processing is supplemented with OCT for 3D characteristics recognition: the OCT sensor scans the part coaxially to the processing laser and as such is independent of the respective illumination and clamping situation.



The 3D information created with VisionLine OCT Detect can be used for the positioning and checking of the part characteristics, like, for example, the height difference of two components.

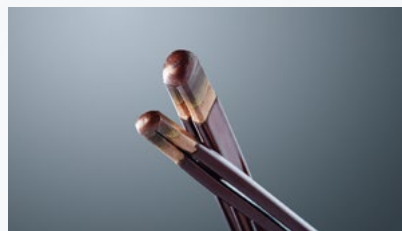

One of the applications for image processing is detecting the position of hairpins in the stators of electric engines.



VisionLine checks the quality of codes as well as text and documents them immediately after marking.



The image processing system detects the position of the pins when welding electronic components.

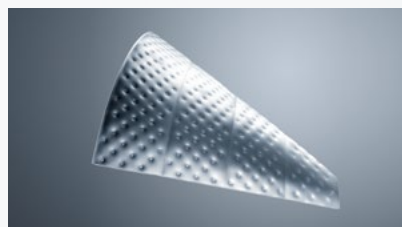

The position of the joining point is reliably detected when welding heat exchangers for example.

The images shown above are examples. The hardware is set up differently depending on the specific application.

03

More good parts

with welding depth monitoring

Thanks to the weld depth monitoring system, production errors, and cross-section samples are finally a thing of the past. The sensor continuously provides data regarding the welding depth and monitors the set limit values during production. This provides you with a documented 100% check for all components and enables you to automatically reject NOK parts.



Reliable results for round parts thanks to continuous monitoring of the welding depth.

04

High-quality weld seams

thanks to temperature control

During laser plastic welding and laser case hardening, ensuring homogeneous results is important, particularly when your component is complex. The integrated temperature control registers the intensity of the thermal radiation on the component surface and regulates the laser power to the desired target temperature.



In laser case hardening, the temperature control can be used to avoid build-up of heat in the edges, holes and corners of components.



In laser plastic welding, the temperature control is used to ensure a high-quality and sealed seam point by uniform heat input along the seam.

05

Controlled meltdown

via melt travel monitoring

The melt travel monitoring system ensures that you maintain control when carrying out laser transmission welding on plastics. The sensor system enables you to always keep track of the lowering of the component and automatically switches the laser off once a defined level of material melting has been achieved. To do this, a conventional inductive melt travel sensor is connected directly to the head of the scanner optics via an analog interface. This enables you to compensate manufacturing tolerances. All relevant data for your quality assurance processes are immediately available to you.



During transmission welding, the melt travel monitoring system constantly checks the melt-down of the material.

06

High repetition accuracy

with automatic focus and power calibration

Sit back and let CalibrationLine check the focus position and laser power on the workpiece – this system makes time-consuming manual checking completely unnecessary. If required, CalibrationLine corrects the focus in the x-, y- and z-direction as well as the laser power. This enables you to make sure that your process specifications are always being complied with and that you always achieve the same results.



Enjoy the benefit of automatically checking and calibrating the tool, particularly in applications with high precision requirements, such as laser remote welding.



If you would like to know more about the advantages of the sensor system, please visit this website: www.trumpf.com/s/sensorsystem

Integration

TRUMPF solid-state lasers for welding, cutting and microprocessing include interfaces to all standard fieldbus systems, making it easy to integrate them into your production line. What's more, TruControl offers you a range of additional options to ensure the perfect control of your production line.

01

Save energy

with intelligent energy management

02

Save your quality data

to the Quality Data Store

03

A variety of interfaces

makes for easy integration

04

Maximum laser safety and productivity

thanks to Performance Level e

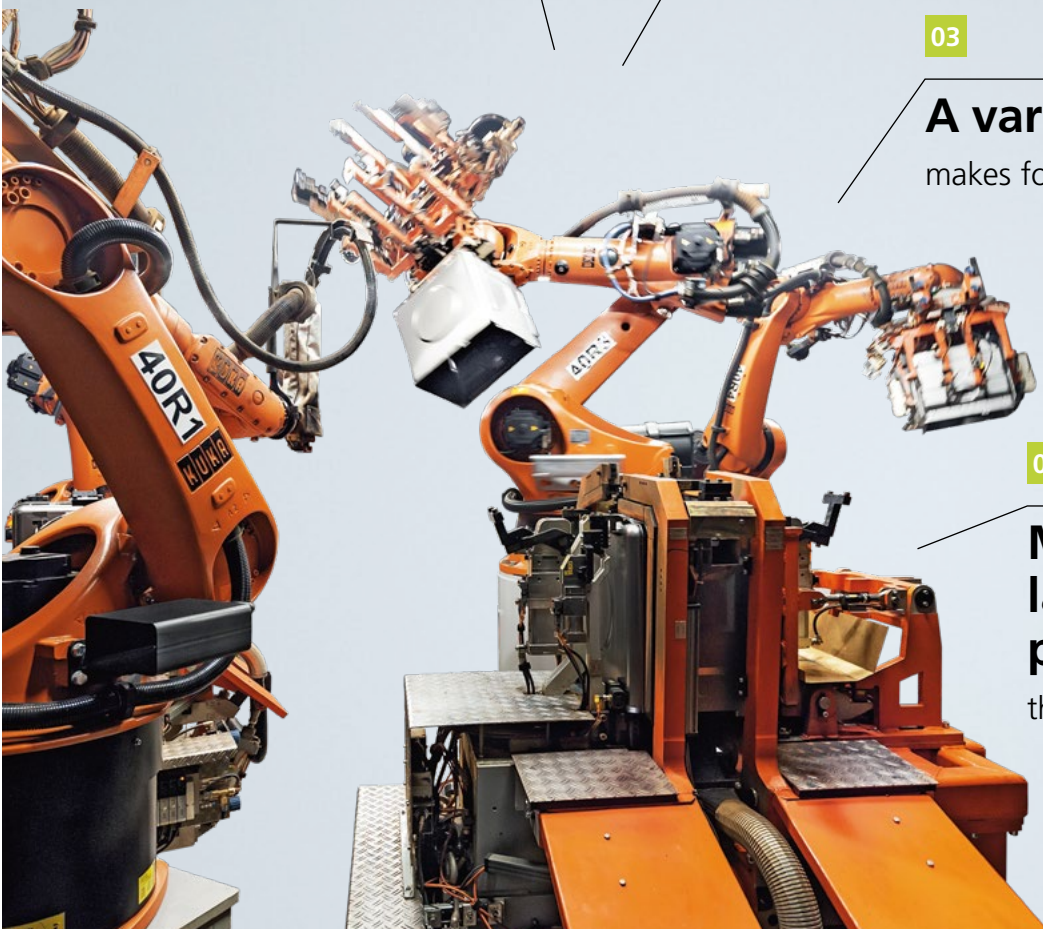

01

Save energy

with intelligent energy management

TRUMPF lasers are renowned for their outstanding energy efficiency. And you can cut energy consumption even more during idle periods thanks to a choice of four different programmable sleep modes, which gradually scale down the laser's power consumption. TRUMPF lasers can also communicate in the intelligent PROFinergy network.

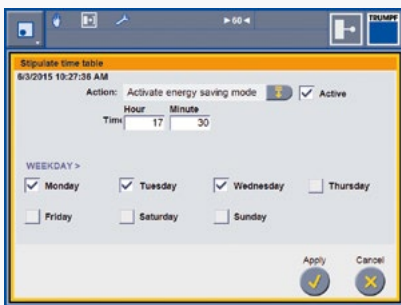

Programmable sleep modes for energy-efficient laser operation.

02

Save your quality data

to the Quality Data Store

The Quality Data Store software module allows you to select relevant laser and processing optics parameters and archive or export them during the laser process. Using unique data such as part numbers and shift information, you can allocate precise laser parameters to each component, even after the process has finished.



The Quality Data Store helps you match each component to the laser used to machine it.

03

A variety of interfaces

makes for easy integration

Interfaces are the key when it comes to integrating a laser into a machine or production line. That's why TRUMPF solid-state lasers come with interfaces to all standard fieldbus systems. The processes are controlled in real time. The TruControl system manages, controls, and visualizes the interface assignment. Users benefit from a standardized control architecture that is compatible with all laser technologies. The standardized OPC UA communication protocol provides the ability to carry out diagnostics and data connection on customer-owned quality management tools.

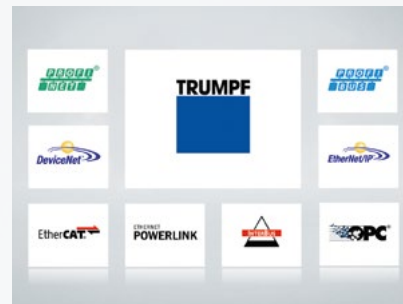

Your TRUMPF solid-state laser can communicate with these fieldbus systems.

04

Maximum laser safety and productivity

thanks to Performance Level e

TRUMPF solid-state lasers are specified as achieving Performance Level e. This represents the highest level of laser safety. Thanks to a uniquely quick deactivation time in the event of a fault, the danger of injury to personnel caused by the laser is reduced to a minimum. This is particularly important for integrating the laser in production plants that involve frequent interaction by the operator (such as for loading and unloading processes). Depending on the plant concept, the safety circuit may in some cases be opened each time components are loaded and unloaded. In this case, the quick activation and deactivation time of the laser has an extremely positive effect on productivity, especially for short cycle times.

TruServices. Your partner in performance

Your laser is designed for maximum performance. For your future success, rely on services that bring benefits in the long-run – together we can find ways to sustainably maximize your added value. With us, you have a reliable partner who supports you with tailor-made solutions and service packages so that you produce cost-effectively and at a consistently high standard.



EMPOWER

If you wish to create the best conditions for successful manufacturing: we will support you in this.

SUPPORT

If flexibility and availability of equipment in day-to-day operations are essential to you: We are there for you.

IMPROVE

If you want to gradually gear your manufacturing to maximum value creation: we will work together to reach your goal.

With TruServices, you receive exactly the products and services you need to be successful in the long term.

Process optimization



Your processes are influenced by an abundance of parameters. There is usually optimization potential in the adjustment of these parameters. To identify them accurately is the basis for the increased efficiency of your production. With our support you are on track to discover the hidden potential of your production. For example, by analyzing your part design, your sub-processes or your whole production. Based on the results, we develop individual or overall solutions together with you, for example, for networked manufacturing.

Product enhancements



Would you like to adapt your TRUMPF system to new requirements even years after the purchase? Product enhancements make it possible for you to retrofit your system with additional functions and technological further developments. You can flexibly integrate new customer requirements – without the necessity of a changing the system.

Service agreements



For your convenience, we have put together different service packages with our service agreements. Choose the scope of services appropriate for you at predictable costs: technical hotline, remote support, scheduled maintenance, repairs, including spare parts – You benefit from reasonable package prices and lower processing expenses.

Monitoring & Analysis



Would you like to have an overview of the status and performance of your machine tool, your laser or your complete production at any chosen time? You gain a maximum of transparency with the monitoring and analysis products from TRUMPF. Monitor statuses and processes in real time and see the success of measures you have introduced. Prevent expensive machine and production standstills and identify potential to save time and costs.



Find out about our comprehensive complete package of helpful services here: www.trumpf.com/s/services

The passion that drives us

Whether production and manufacturing technology, laser technology or material processing: We develop highly innovative products and services for you that are fit for an industrial setting and absolutely reliable. We do everything within our power to provide you with a convincing competitive advantage: with our know-how, experience as well as blood, sweat and tears.

Industry 4.0 – solutions to safeguard your future

The fourth industrial revolution is changing the manufacturing world. How can you stay competitive internationally? Take advantage of the opportunities of digital networking with TRUMPF Condition Based Services: you see more, know more and get the best out of your laser beam sources and your whole production.



Smart View Services

You get an independent overview of the status of your lasers with the Smart View Services. Based on an IT-secure data transmission, status data are transmitted and displayed automatically in the form of clearly structured dashboards. With this consolidated information, you save on maintenance time and can prevent standstills by initiating measures on time and thereby increase availability and productivity.

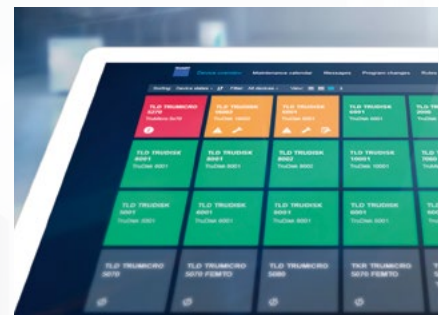

TRUMPF Condition Monitoring

With TRUMPF Condition Monitoring, our service experts and algorithms monitor your lasers for predictive maintenance. You can find the results of the analysis in the cyclical condition monitoring reports. To reduce foreseeable idle time, you are, of course, proactively informed about developments that could cause a standstill.





Visit us on
YouTube:
[www.youtube.com/
TRUMPFtube](http://www.youtube.com/TRUMPFtube)



Lasers for manufacturing technology

Whether in the macro, micro or nano range: We have the right laser for every industrial application and the right technology to produce innovatively and cost-efficiently at the same time. Beyond the technology itself, we support you with system solutions, application knowledge, and consulting.

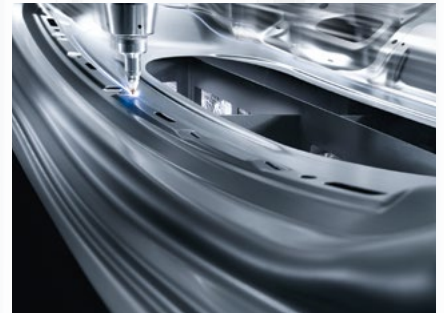

Power supplies for high technology processes

From semi-conductor production to solar cell production: Thanks to our HF and MF generators, current for induction heating, plasma and laser excitation takes a defined form in terms of frequency and performance – highly reliable and repeatable accuracy.



Machine tools for flexible sheet metal and tube processing

Laser cuttings, punching, bending, laser welding: We offer you perfectly suited machines and automation solutions, including consultation, software and services for all procedures used in flexible sheet metal processing, so that you can reliably manufacture your products in high quality.



TRUMPF is certified according to ISO 9001
(Find out more: www.trumpf.com/s/quality)



TRUMPF Laser- und Systemtechnik GmbH
www.trumpf.com