



**TRUMPF**



Laser systems

The answer  
to your  
manufacturing  
needs

# The perfect solution

Thousands of satisfied customers place their trust in machinery made by the world's leading technologist in laser material processing. Laser systems from TRUMPF give you the security of knowing you have chosen a highly flexible and extremely productive solution for your processing needs. We will support you every step of the way, from developing your application to choosing the right technology, components, and software – and we even offer comprehensive after-sales services. Together we can boost your productivity.

Your industry partner: We want to share our expertise with you.

**In good hands no matter  
what industry**  
4–7

In our Laser Application Centers, we work together with you to develop your process right from the very beginning.

**We can help you  
rise to the challenge**  
8–9

TRUMPF delivers sophisticated complete solutions that have proven their mettle.

**Everything from a single  
source**  
10–11

Diverse solutions for varied tasks: Together we will find the right one for your production line.

**Your application,  
our technologies**  
12–13



Best conditions for a successful production.

**Smart Services  
14–17**

Everything goes quickly with this software solution.

**Easy programming  
18–19**

An overview of the intelligent functions of all machine series.

**Function overview  
20–21**

Find out more about our product range here.

**The answer to your  
manufacturing needs  
22–59**

Our comprehensive services and unwavering support will give you a competitive advantage.

**TruServices.  
Your Partner in Performance  
60–61**

All the technical information you need at a glance.

**Technical data  
62–65**

# In good hands no matter what industry

What drives you drives us too. For many decades now, we have been offering customers from a wide range of industries help and advice on using laser technology. The knowledge we have acquired over this time gives us an edge that we aim to pass on to you: You can expect technology that is both state of the art and tailored to the specific needs and concerns of your industry. TRUMPF is always at the forefront of the latest trends, and is continually investing in the research and development of new technologies and potential applications to ensure we maintain this leading position in the future too.

## Anywhere and everywhere

Laser material processing has been an integral part of numerous vehicle sub-assemblies for many years now. Almost every component – from the drivetrain through to custom decorations – has had a laser involved in its manufacture.



See the versatility that working with laser tools offers across all industries:  
[www.trumpf.com/s/kecj9f](http://www.trumpf.com/s/kecj9f)

---

## Automotive industry

---

Laser technology has been a part of contemporary car manufacture for many years now. The automotive industry is a global one – and TRUMPF is a global company: Customers around the world can rely on premium service, high spare parts availability, and an expert team of industry managers and product managers who are supported by sales staff with encyclopedic knowledge of products and industries. Our industry expertise has been acquired over decades and will take your production process to the next level.



### Automobile body work

When working on car bodies, you always need very high speed and flexibility. With our laser systems, you can even process modern lightweight materials such as aluminum and hot-formed steel. With TRUMPF, you can bank on innovative, industry-adapted solutions for your welding, cutting, ablation, soldering and adhesive-preparation operations.



### Electromobility

Use laser technology to turn your ideas for high-performance, compact components into reality. Or benefit from new joining geometries for conductive metals and the ultrafast welding of batteries and electrical components – with minimal spatter and heat input.



### Lightweight design

Laser technology can open the door to modern-day lightweight construction, enabling you to process press-hardened and high-tensile steels, aluminum, fiber-reinforced materials, and hybrid material joins in a cost-effective way. Lasers even make it possible to use entirely new types of lightweight construction, such as intelligent structures or 3D-printed components, which will bring marked improvements to your product.



### Powertrain

Working with drives often takes you to the limits of possible joining technology. To machine your drive components you need stable, spatter-free processes and deep, flawless seams that are long-lasting and can withstand harsh conditions. The laser technology from TRUMPF makes all of this possible.



## Medical engineering

Nowhere is having reliable processes more important than in medical engineering: With TRUMPF you can count on ultraprecise, reproducible results without the need for reworking, plus highly flexible production from batch size 1. The laser light works contactlessly, meaning that sterility is assured at all times. Being marked with a laser ensures that parts are traceable in accordance with UDI standards, while 3D printing offers maximum customization of artificial hips or dentures.



## Electrics/electronics

Fast processes in fully automated production lines, high-precision processing and minimal exposure to heat for your workpiece: Laser systems from TRUMPF make achieving these things effortless. A laser also enables you to engrave an extremely high number of sensitive electronic components at the same time – without contact and free from wear.

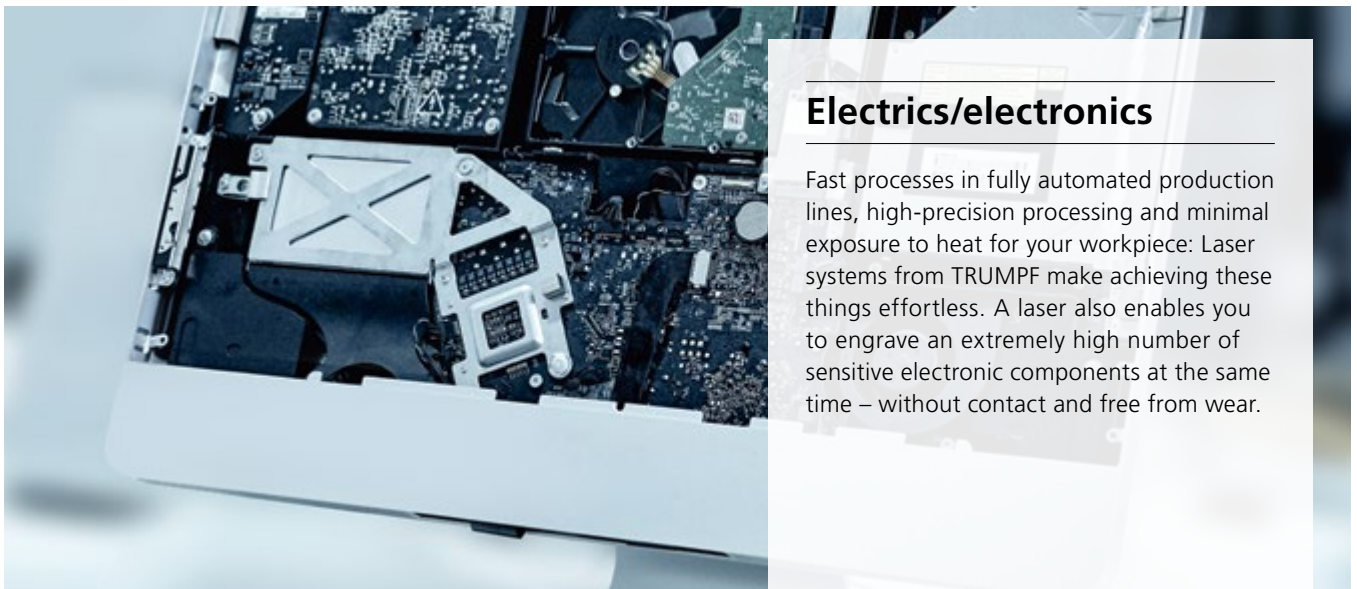

## Sheet metal working

Sheet metal working requires speed and flexibility. TRUMPF laser systems enable you to quickly and easily carry out retooling, welding, cutting, and deposition welding with a single machine, while also offering fast processing, an intuitive operating concept and assistance with application development.

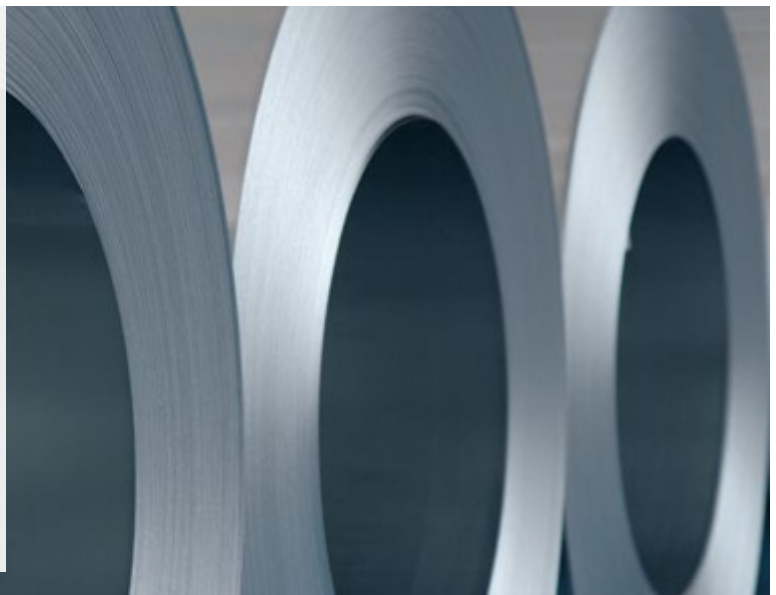



---

## Utility vehicles and transportation

---

Modern laser machines are consistently reliable and bring down the cost per part, for example when doing welding jobs or the laser cutting of automotive body parts. Procedures such as laser metal deposition help to repair components cost-effectively instead of having to replace them. In this regard, TRUMPF is a dependable partner for automatable solutions.

---

## Aviation and aerospace industries

---

From expensive certification processes and premium part quality to reliable reproducibility, the demands made in the aviation and aerospace industries are enormous. But with engineering from TRUMPF, you don't have to worry about meeting them: we offer cutting-edge technologies such as laser deposition welding and 3D printing to the highest standards, and we are here to help you with a global service team.



---

## Science

---

Are you conducting research into the properties of new or unusual materials? Or perhaps you're developing processing strategies for the industrial production line of the future? Then you need state-of-the-art laser systems that are reliable and offer flexible parameterization. TRUMPF is helping numerous universities and institutes to acquire new knowledge.



# We can help you rise to the challenge

Whether you know exactly what you need or you're looking for a custom solution, we will be there for you every step of the way. We are fascinated by lasers and all the possibilities they offer. In our Laser Application Centers (LAC) we are ready and waiting to assist you – no matter when, no matter where. This is because we want you to find the right partner in the right place who always has the right technologies for your needs.



"With our tailor-made service packages, we are there at your side in the midst of your running operation. Our comprehensive remote services offer quick, uncomplicated help when errors occur – and, thanks to TRUMPF Condition Based Services, even before they occur. We also offer a broad spectrum of consulting with training courses, product enhancements and application services provided directly at your site."

Benjamin Blocksdorf, Group Leader of Sales for Global Services, Ditzingen

"The industry management provides our customers with support long before they put the laser into operation. As early as the product development phase, our team of experts and key account managers provide step-by-step support for projects in industries like automotive and entertainment electronics. Working together with you, we develop tailor-made solutions to ensure you get the full potential of the laser technology in your production processes. In addition to current topics such as the electrification of vehicles or display technology applications, the further development and optimization of existing processes are very important to us."

Marc Kirchhoff, Head of Branch and Global Key Account Management, Ditzingen

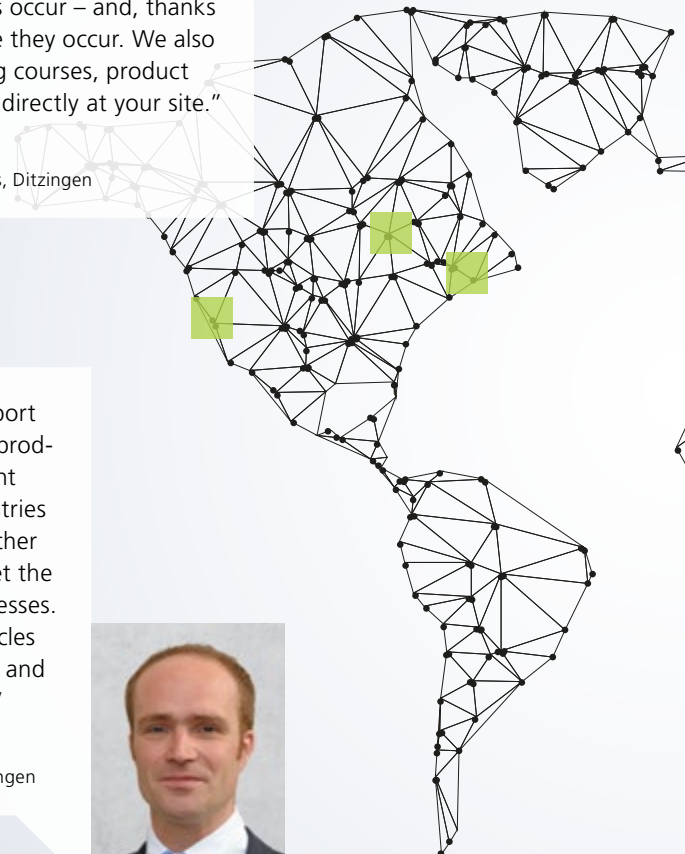



“TRUMPF helped us enter the market for 3D cutting high-strength steel grades. We received so many orders we soon had to purchase a second laser system.”

Gerardo Oaxaca, CEO of Superlaser & Fixtures, Puebla



Photo: Adam Wiseman

“TRUMPF’s technical expertise helped us finally find an automatable laser cutting solution. It’s done away with the need for two out of three work steps. Plus we can react more quickly to design changes in manufacture.”

Ulrich Nieweg, Head of Prefabrication/Tool Making at Zwilling J. A. Henckels AG, Solingen



Photo: Ralf Kreuels

“The demands on productivity and production control are constantly increasing in industry. In order to set new standards, we develop software and service packages that can predict downtimes or maintenance missions of the equipment. We work closely with our customers to precisely align product development with customer benefit.”

Florian Kiefer, Head of Product Management Services, Ditzingen



Find out more about how we can help you at our Laser Application Centers here: [www.trumpf.com/s/7smpvy](http://www.trumpf.com/s/7smpvy)

# Everything from a single source

TRUMPF gives you the security of knowing you have chosen a sophisticated and proven solution for your manufacturing system. Our numerous components – all of which we make ourselves – and our fully comprehensive global service make us a reliable partner for your production needs. You will also benefit from our knowledge of key issues for the future, such as Industry 4.0 and additive manufacturing.

## Everything for your machine

- Machine
- Laser
- Procedure-specific processing optics
- Sensor technology
- Software
- Custom solutions



## Everything for your manufacturing processes

- Automation solutions
- Construction of jigs and fixtures
- Part and powder management in additive manufacturing
- Laser network





### Why choose TRUMPF laser systems?

- 1 Tailored solutions
- 2 Optimal for large-scale production and batch size 1
- 3 Consistently high component quality
- 4 Virtually warp-free processing
- 5 Highly precise results
- 6 No reworking needed
- 7 Maximum productivity minimizes cycle times
- 8 Process flexibility (cutting, welding, LMD)
- 9 Extremely robust and reliable
- 10 Maximum machine availability

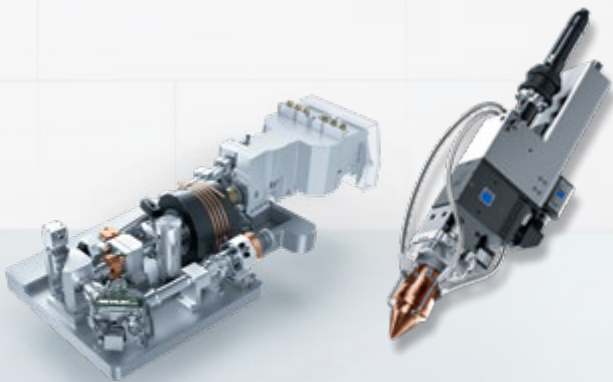

### TruServices. Your partner in performance

- Worldwide technical service
- Functional enhancements
- Monitoring and analysis
- Training
- Application advice



### The best complete solution for your manufacturing process

We place extremely exacting demands on our products in terms of their technology, engineering, quality, and usability in practice. We guarantee you won't fail to notice this.





# Your application, our technologies

Our customers come from a wide variety of industries and they each have their own unique processing tasks, since every application places very specific demands on technology. TRUMPF offers laser systems that cater to all industrial applications, whether you work with rapid mass manufacture or batch size 1, from robust joining to fine separating or additive manufacturing: You will find the right solution for your manufacturing needs in our product range. You can obtain everything from a single source, from beam sources and system solutions through to beam guiding components, processing optics and intelligent sensor systems.



Find out more about what lasers can do and how you could use laser technology in your work here:  
[www.trumpf.com/s/k4ivz1](http://www.trumpf.com/s/k4ivz1)

	TruLaser Cell 1100	TruLaser Cell 3000	TruLaser Cell 5030	TruLaser Cell 5030 Hotforming Edition	TruLaser Cell 7040	TruLaser Cell 8030	TruLaser Station 7000	TruMark Station 3000	TruMark Station 5000/7000	TruPrint 1000/2000/3000/5000
<b>Welding</b>	■	■	■		■		■			
<b>Deposition welding</b>		■			■					
<b>Plastic welding</b>							■			
<b>Cutting</b>		■	■	■	■	■				
<b>Drilling and removing material</b>		■*							■	
<b>Hardening</b>		■*								
<b>Generating</b>		■			■					
<b>Marking</b>								■	■	
<b>Metal 3D printing</b>										■

\* Upon request.

# Smart Services

 **Transparency**

 **Availability**

 **Productivity**

 **TruLaser Cell 8030**





Would you like to sharpen your competitive edge? Digital networking offers you many advantages: You see more, know more, and get the best out of your laser systems and your overall production. With Smart Services, you already have a complete overview of the condition of your lasers and laser systems. TRUMPF service experts and algorithms also help you avoid unplanned downtimes and to detect possible malfunctions in good time.



# Your Smart Services at a glance

## OPC UA interface: The interface for connecting to your own network solutions

Open Platform Communications Unified Architecture (OPC UA) is the open, platform-independent and flexibly scalable communication standard for the industry. It includes a unique information model that not only carries data but also supports the data's semantic properties. The built-in security mechanisms that come with the protocol enable access control and encryption.

With OPC UA, you have the opportunity to network your machinery and prepare applications for Industry 4.0. All our lasers and components are OPC-UA-capable. In older key models, the interface can be retrofitted with what is known as an OPC UA retrofit box. With TRUMPF Condition Monitoring, Smart View Services and Quality Data Storage, we offer turnkey solutions based on the OPC UA interface.

### Infrastructure and data flow

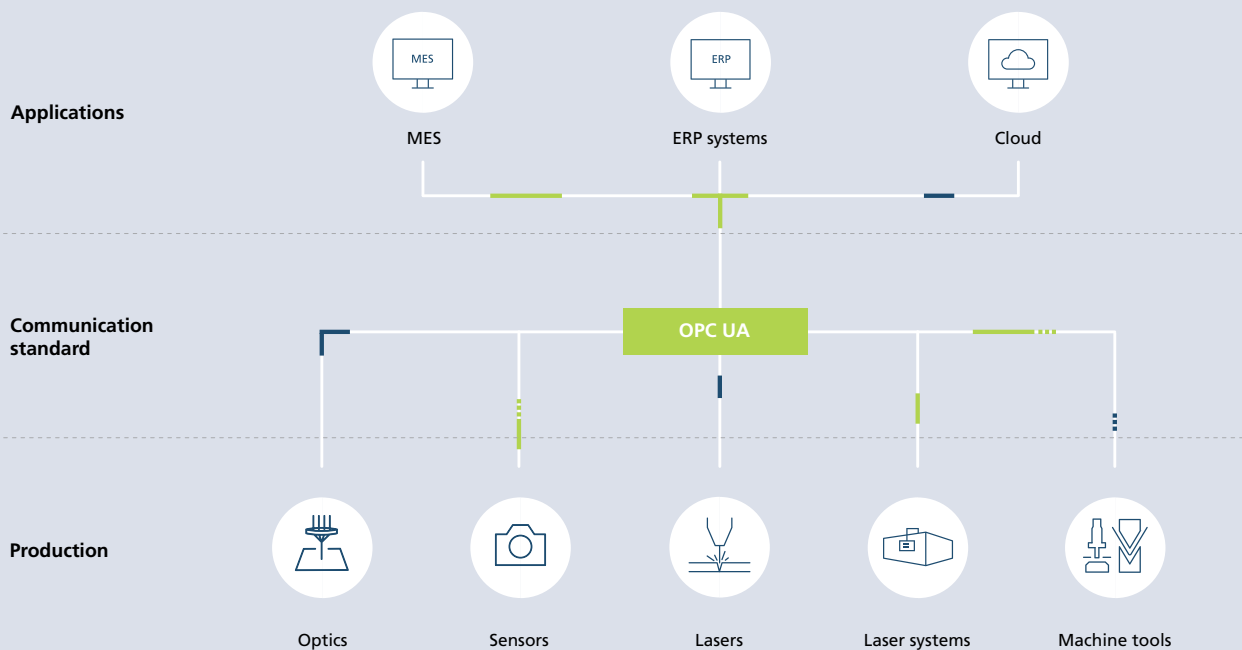

## Increased machine availability thanks to TRUMPF Condition Monitoring

Have your laser and laser systems reliably monitored by algorithms and TRUMPF experts. We proactively contact you and help you avoid unplanned machine downtimes. This will increase the availability of your machines. At the same time, you benefit from the timely planning and preparation of service assignments.



## Greater transparency with Smart View

### Status data

With Smart View, you can independently gain an overview of the status of your laser systems. Data is transmitted and automatically displayed in the form of clear dashboards based on IT-secure data transmission. If necessary, you access detailed views. In addition to the status conditions, you will also receive information about error messages that have appeared, the utilization of the lasers, pending maintenance measures, and an evaluation of the utilization.

### Program changes

In the program change manager, you follow the changes that have been made in the machine program and in the laser technology tables. Changes in day-to-day production can thus be easily and transparently tracked. The data also assists with documentation and quality assurance.

### Production reports

The production reports allow you to check the run-through of previous shifts. This makes it easy to understand optimization potential in production and errors in the event of downtime. In addition, you can also compare the utilization of the machines with each other or over time.

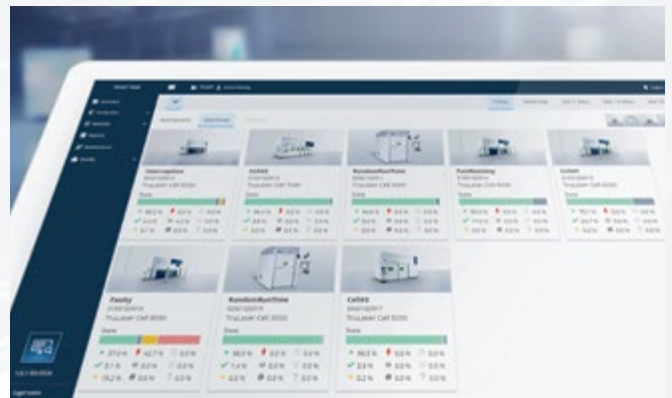



# Easy programming

With TRUMPF software solutions, you can operate and program your laser machines in no time at all – easy to use and, being based on the entire TRUMPF know-how, with reliably good results. This is how you get the best results from your machine.

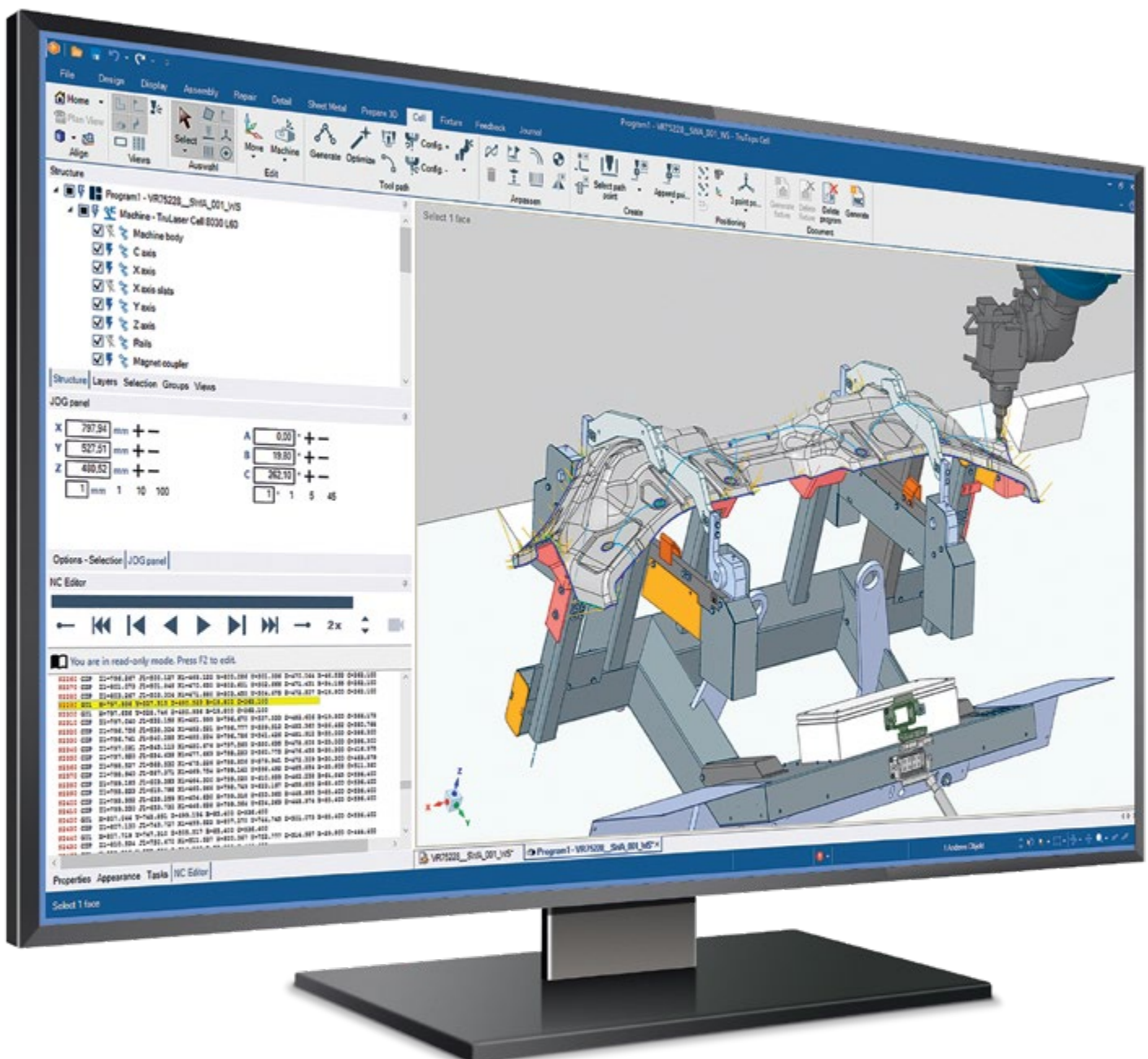

You can find further information here:  
[https://www.trumpf.com/filestorage/TRUMPF\\_Master/Products/Software/Brochures/TRUMPF-Software-EN.pdf](https://www.trumpf.com/filestorage/TRUMPF_Master/Products/Software/Brochures/TRUMPF-Software-EN.pdf)

## TruTops Cell Basic

Check and modify processing programs directly at the machine.

### Optimal process reliability thanks to visual feedback

The program visually simulates the individual programmed processing steps. This way, you can quickly check if you will get the result you want. Every program change is immediately visible.

### Easy optimization of existing programs

Besides the direct programming of the NC program, you can make direct changes with the intuitive graphic user interface of the machine control. This way you save a lot of time in the midst of ongoing operations.

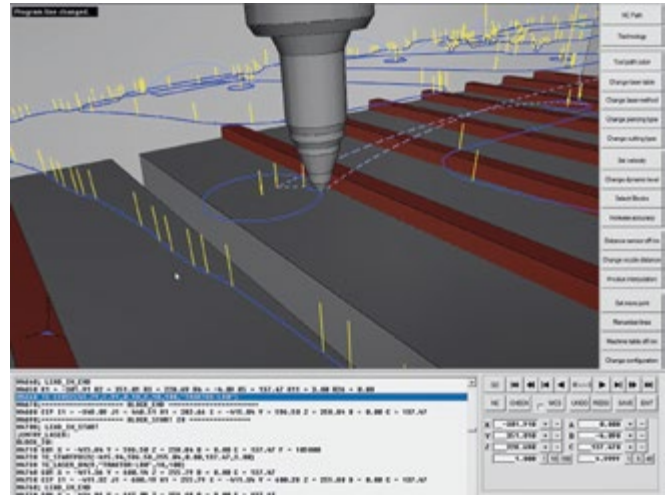

## TruTops Cell for 3D processing

Comprehensive solution for cutting and welding

### Offline programming

The machine continues to run while you are already generating or adapting new NC programs at your computer. The processing program can predict possible collisions, automatically preventing them and optimizing processing trajectories. The modifications you make at the machine control are immediately adopted by TruTops Cell.

### Automatic optimization

With just a few clicks, you can select the most suitable stored technology settings and use them to perfect your machining process. The entire TRUMPF know-how has flowed into the

program, and it automatically prepares for you the right process parameters for your application.

### Integrated fixture module option

With TruTops Cell, you can generate a CAD model of the suitable cutting fixture with just a couple of clicks. Clever additional functions then optimize it further.

### Compatible with all data formats

TruTops Cell can be used with all current data formats. Being equipped for cutting, welding and laser metal deposition, the program also supports all TruLaser Cell machines.

## TruTops Boost for efficient 2D laser cutting

Get even more out of your machine.

### Efficient machine utilization thanks to algorithms

A common pool of orders and the Lean Nest nesting processor provide what you need for optimal material utilization. The software also shows you an overview of the statuses of your orders.

### Automatic part tracking

Equip your production unit for Industry 4.0. With a great number of other optional functions, this program will open up whole new perspectives for modern production control.

### Automatic and interactive operation



The intuitive operation of this software enables you to work with even greater productivity. The choice is yours as to whether you program interactively or leave it up to the automatic functions of the software.



# Intelligent functions

Which intelligent functions are available with which machine series?

This table gives you a quick overview.

	 TruLaser Station 7000	 TruLaser Cell 3000
<b>Technologies</b>		
<b>Cutting</b>		■
<b>Welding</b>	■	■
<b>Laser metal deposition</b>		■
<b>Funktionen</b>		
<b>X-Blast:</b> Greater machine availability and better edge quality when laser cutting 3D parts because you double the clearance between the nozzle and sheet		
<b>BrightLine Weld:</b> Low-spatter, energy-efficient laser welding using the revolutionary BrightLine Weld technology with patented 2-in-1 LLK	■	■
<b>BrightLine Speed:</b> The option enables a faster cutting speed, improves process robustness and decreases cutting gas consumption		
<b>ObserveLine:</b> Patented check system for the automatic check of axis precision and automatic check for fallen cut-out waste at an unprecedented speed		■
<b>Dynamic cutting optics:</b> Highly dynamic extra axis in the optics for the fastest distance regulation possible and maximum performance		
<b>VisionLine:</b> Intelligent process viewing with a digital camera image in the laser focal point and many additional functions	■	■
<b>Smart Optics Setup:</b> Test station which can be swiveled into the working area for fast and reliable execution of typical setup tasks		
<b>CalibrationLine Power:</b> Automatic inspection of your laser power to ensure constant processing quality	■	■
<b>FocusLine:</b> Automatic correction of the focus point while processing		■
<b>FocusLine Professional:</b> Optical system for continuous spot diameter and focal diameter variation		■
<b>FastLine Cell:</b> Piercing on-the-fly for higher productivity		
<b>Smart Approach:</b> Patented system for faster and more reliable approach to the outer edge of the component, for the shortest possible cycle time with outer cuts		
<b>TruTops Cell Basic:</b> Graphical user interface on the machine control for the convenient checking and modification of programs, with visual simulation		■





# TruLaser Cell 1100

The specialist in the laser welding of tubes, profiles and straps

01

## Easy to integrate

thanks to a flexible,  
compact structure

02

## Extremely efficient

thanks to state-of-the-art beam  
sources and calibrated sensors

03

## Perfectly accessible

through variable adjustable axes

04

## Fully customized

Optional extras offer solutions  
for every application



01

## Easy to integrate

thanks to a flexible, compact structure

Make life easy for yourself: The compact and modular TruLaser Cell 1100 can be integrated into your production lines with the utmost ease. You can configure the beam guidance system to meet your specific needs in terms of the linear axes, the working height or process path. This makes it possible to weld in two different places at the same time.



Non-stop manufacture – the system for endless welding professionals.

02

## Extremely efficient

thanks to state-of-the-art beam sources and calibrated sensors

With the TruLaser Cell 1100, you can step your production process up a gear. Simply choose the right beam source for your application – CO<sub>2</sub> laser or solid-state laser – and the system is highly flexible when it comes to positioning the beam and optics. The perfectly calibrated sensors guarantee optimum welding results. All of these factors together cut your operating costs and increase your production speed.

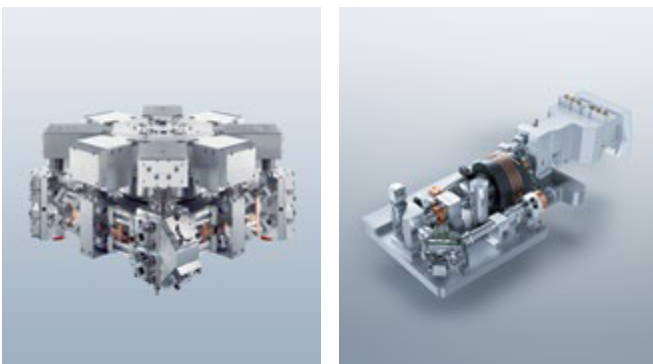

Use the beam source you need: The TruFlow CO<sub>2</sub> laser (left) or the TruDisk disk laser – the choice is yours.

03

## Perfectly accessible

through variable adjustable axes

The variable setting axes offer ideal adjustment options, for both tubes and profiles. Thanks to its compact design, the variable beam guidance can be integrated into all current profile systems. The sophisticated beam forming feature enables top welding quality at maximum feed even with high requirements and the most diverse of seam geometries.



Equipped with the most modern process technology for demanding tasks.

04

## Fully customized

Optional extras offer solutions for every application

Be more flexible thanks to a wide range of welding optics with linear or swivel axes. Sensor systems for finding and tracking seams together with functions such as SeamLine and SeamLine Pro guarantee maximum quality, reliability and productivity.

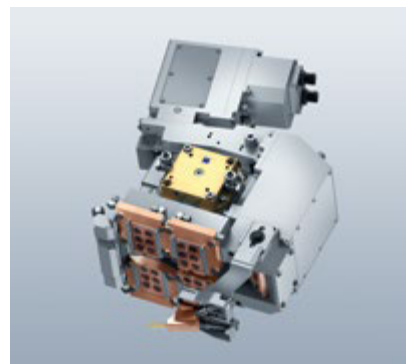

You too can achieve the perfect seam with the right process monitoring system.



You can find still more information about the TruLaser Cell 1100 here: [www.trumpf.com/s/20q1n3](http://www.trumpf.com/s/20q1n3)



# TruLaser Cell 3000

The universal machine for the 2D and 3D laser welding, laser cutting and laser metal deposition of small to medium parts

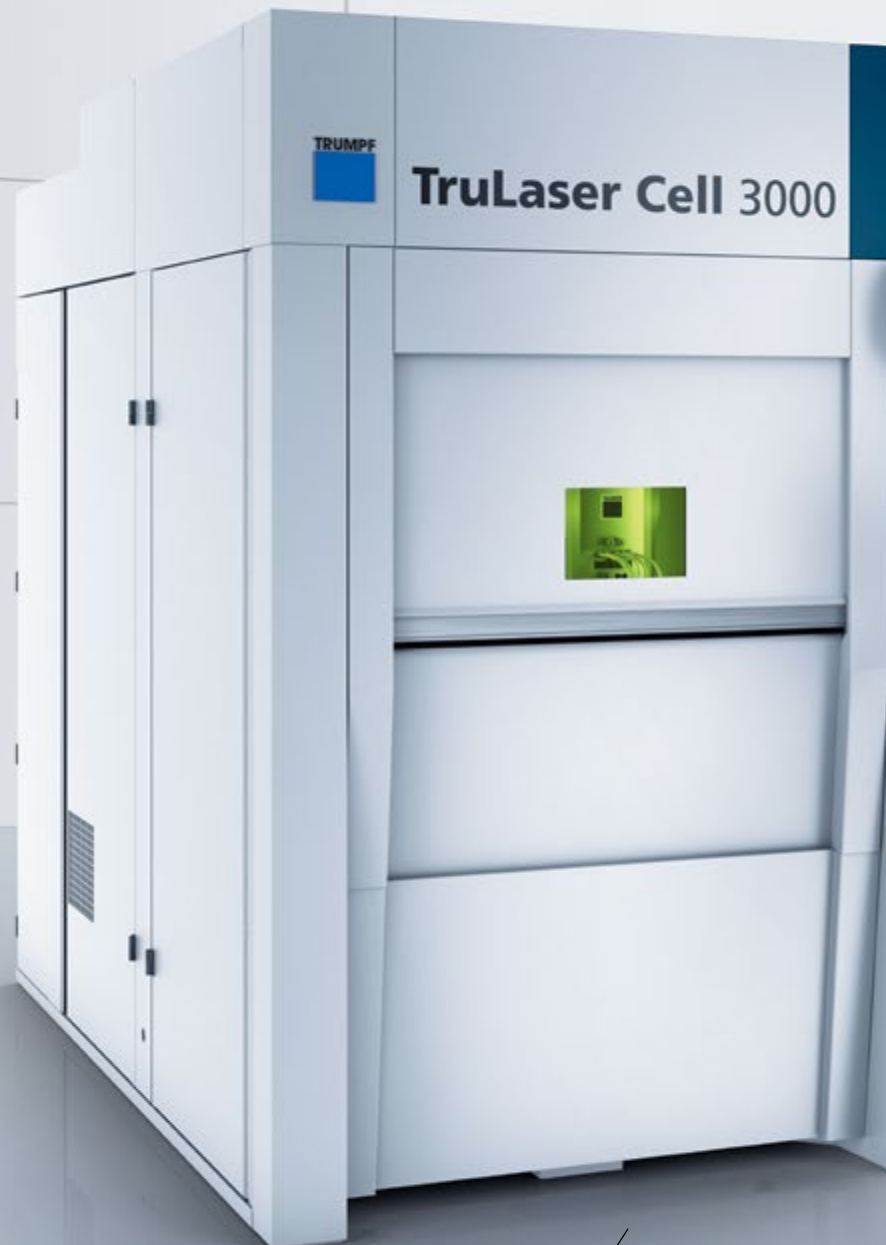

01

## Unique process flexibility

Welding, cutting, laser metal deposition

02

## Highly productive processing

due to customized automation solutions and a dynamic axis system



05

## Spacious and most flexible work area

with compact machine design

04

## Reliable processing

due to intelligent image processing and laser power sensor system

03

## Cost-efficient production

with top component quality



You can find anything else you would like to know about the TruLaser Cell 3000 here: [www.trumpf.com/s/woxy9](http://www.trumpf.com/s/woxy9)

01

## Unique process flexibility

Welding, cutting, laser metal deposition

Trend-setting flexibility without compromise. Having a broad variety of functions available, the machine can be equipped for every application. With the flexible optical interface, even scanner optics of the PFO series can be attached, for example, to weld e-mobility components. An interpolating rotation-swivel axis offers optimal 3D accessibility for laser metal deposition.

### Welding



### Cutting

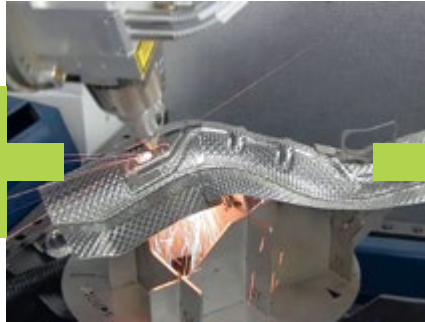

### Deposition welding



02

## Highly productive processing

due to customized automation solutions and a dynamic axis system

High quantities? No problem. Using a rotary table for loading and unloading parallel to production, and a highly dynamic axis system with a linear drive, you will cut down your production times considerably. The automatic lateral lifting doors enable the system to be connected to a transfer system and loaded by robots. The ability to automate the TruLaser Cell 3000 makes it easy to integrate into complete production lines.



The TruLaser Cell 3000 can be automated very easily, for example from the front with robots, or laterally with a coil connection or to a flow line.



03

## Cost-efficient production

with top component quality

When it comes to laser welding, BrightLine Weld sets new standards with regard to the welding speed and quality. Depending on the material concerned, it enables an increase in the feed rate of up to 300% or a reduction in energy consumption of up to 40% whilst ensuring the same welding depth. In combination with the highly precise axis system, this ensures the very best component quality at all times.

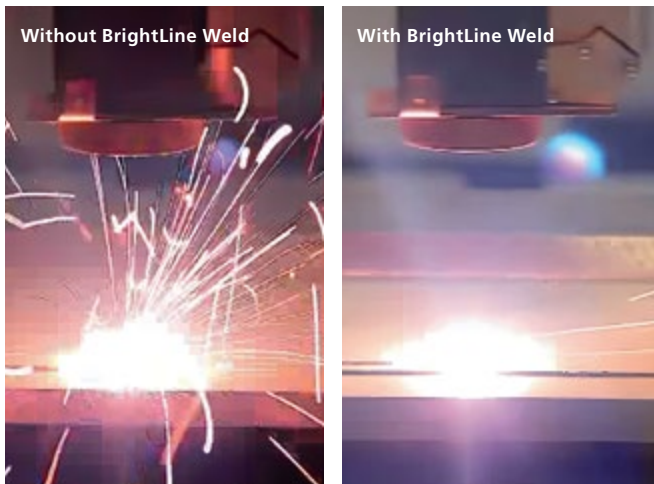

With BrightLine Weld, materials such as mild steel, stainless steel, or even copper and aluminum can be welded virtually spatter-free.

05

## Spacious and most flexible work area

with compact machine design

More for your money: Boasting the largest and most flexible work area in its class, the TruLaser Cell 3000 not only offers space for large installations and comprehensive fixtures and automation systems. With an additional motor-driven workpiece axis, you can also process 3D components which are up to 50% larger.

04

## Reliable processing

due to intelligent image processing and laser power sensor system

Powerful sensor systems ensure comprehensive process monitoring and fault-free machining processes. VisionLine image processing automatically detects the position of the component, forwards the information to the controls, and ensures that the weld seam is always positioned in the right place. CalibrationLine guarantees a constant laser power on the workpiece.

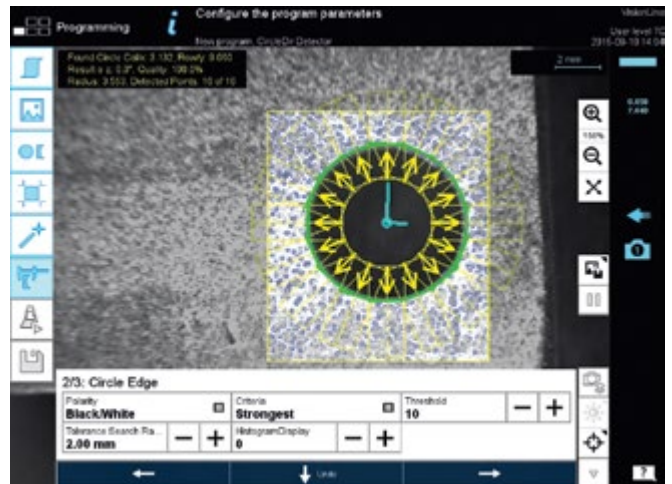

The image processing automatically measures the component, ensures safe and reliable processes during welding, and prevents the production of faulty parts.

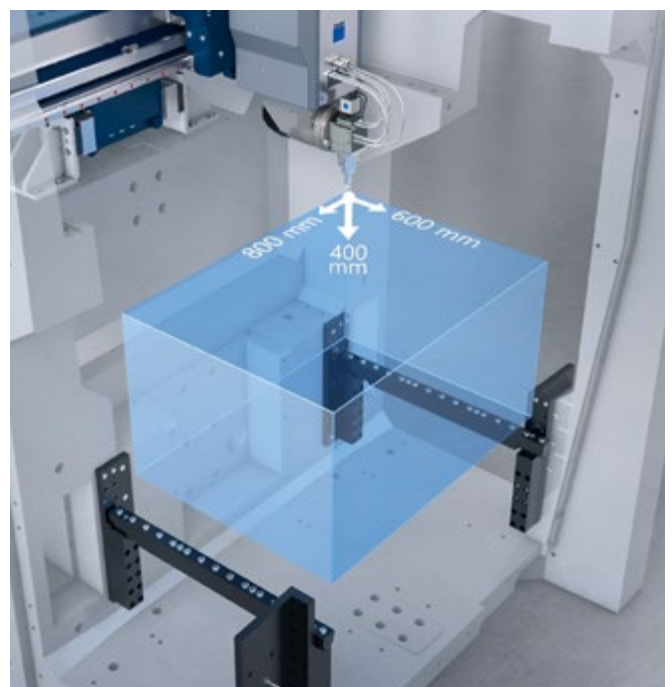

The large work area can also be accessed from the side and enables large components to be processed in a minimal installation area.

# TruLaser Cell 5030

The entry model for 2D as well as 3D laser cutting and welding of large parts



01

## Low-cost introduction

to 3D laser cutting and welding

02

## Top operator convenience

due to intuitive software support



03

**Dynamic and precise**  
with flying optics

04

**Top quality**  
due to unique features

05

**Process flexibility for cutting and welding**  
with 2-in-1 LLK



More information about the TruLaser Cell 5030 can be found here:  
[www.trumpf.com/s/j5ra70](http://www.trumpf.com/s/j5ra70)



01

## Low-cost introduction

to 3D laser cutting and welding

Cost-efficient processing starting with the very first part: Compared to hybrid and sheet mover machines with CO<sub>2</sub> lasers, the TruLaser Cell 5030 achieves up to 300% higher performance with a machine-hour rate reduction of up to 20%. Its clever design reduces the installation area of the system to a minimum.



The system impresses with low maintenance costs.

02

## Top operator convenience

due to intuitive software support

The TruLaser Cell 5030 is optimal for the processing of frequently changing orders with small lot sizes. The running-in of new parts is supported by clever features like, for example, the stored technology parameters for all currently used materials, the TruTops Cell Basic program for quick program modifications or the automatic focus setting. The front doors of the machine are made of light CFRP material, enabling quick and convenient access to the work area.



The teachbox allows you to operate your machines easily and with flexibility.

03

## Dynamic and precise

with flying optics

With X-Blast Technology you work at a greater distance to the sheet metal. This reduces nozzle collisions and increases the quality of the 3D cutting edges. Flying optics also contribute to precise results. Nevertheless, in the event of a collision, the magnetic coupling prevents damage to the machine.

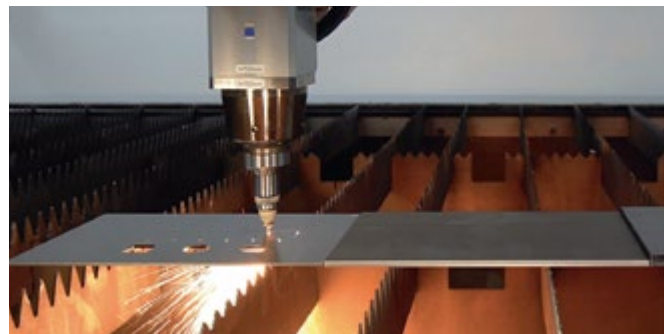

Extremely high processing speeds are enabled by the same optical setup and drive principle as in 3D high-end machines.

04

## Top quality

due to unique features

Optimal coordination between laser, machine, and software forms the foundation for excellent processing quality. With the TruLaser Cell 5030 you have all three building blocks from TRUMPF. Machine operators are supported by the latest functions such as Smart Optics Setup, for a quick and convenient setup. The precision of the machine can be automatically tested during the production process with ObserveLine Professional. This reduces the production of faulty parts to a minimum. The BrightLine Weld option enables laser welding almost free of spatter and optimal weld seam quality. At the same time, significantly higher feed rates can be achieved with this option, and energy costs can be reduced.



You can weld materials such as mild steel, stainless steel or even copper and aluminum almost free of spatter using BrightLine Weld.

05

## Process flexibility for cutting and welding

with 2-in-1 LLK

The 2-in-1 LLK solution for solid-state lasers enables the use of the same optical cable for both welding and cutting operations. When switching between the two methods, only the processing optics has to be changed, the system control then adjusts the laser beam automatically. And you will also be impressed by the easy operation and top processing results. The standard work table used in all applications is also available as a moveable table. Special 3D work tables are also available as an alternative.

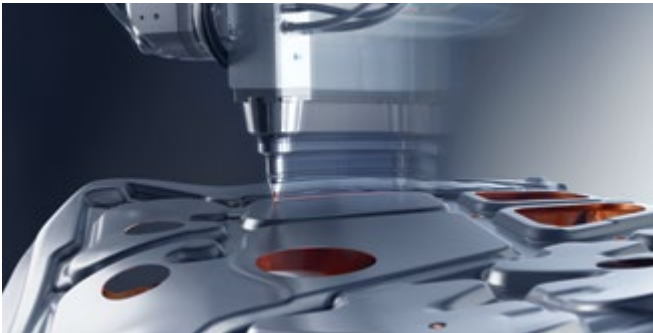

The same optical setup and working principle used with the high-end 3D machines make top processing speeds possible.



The manually adjustable focus position enables you to perform both deep penetration and heat conduction welding with the same processing optics.

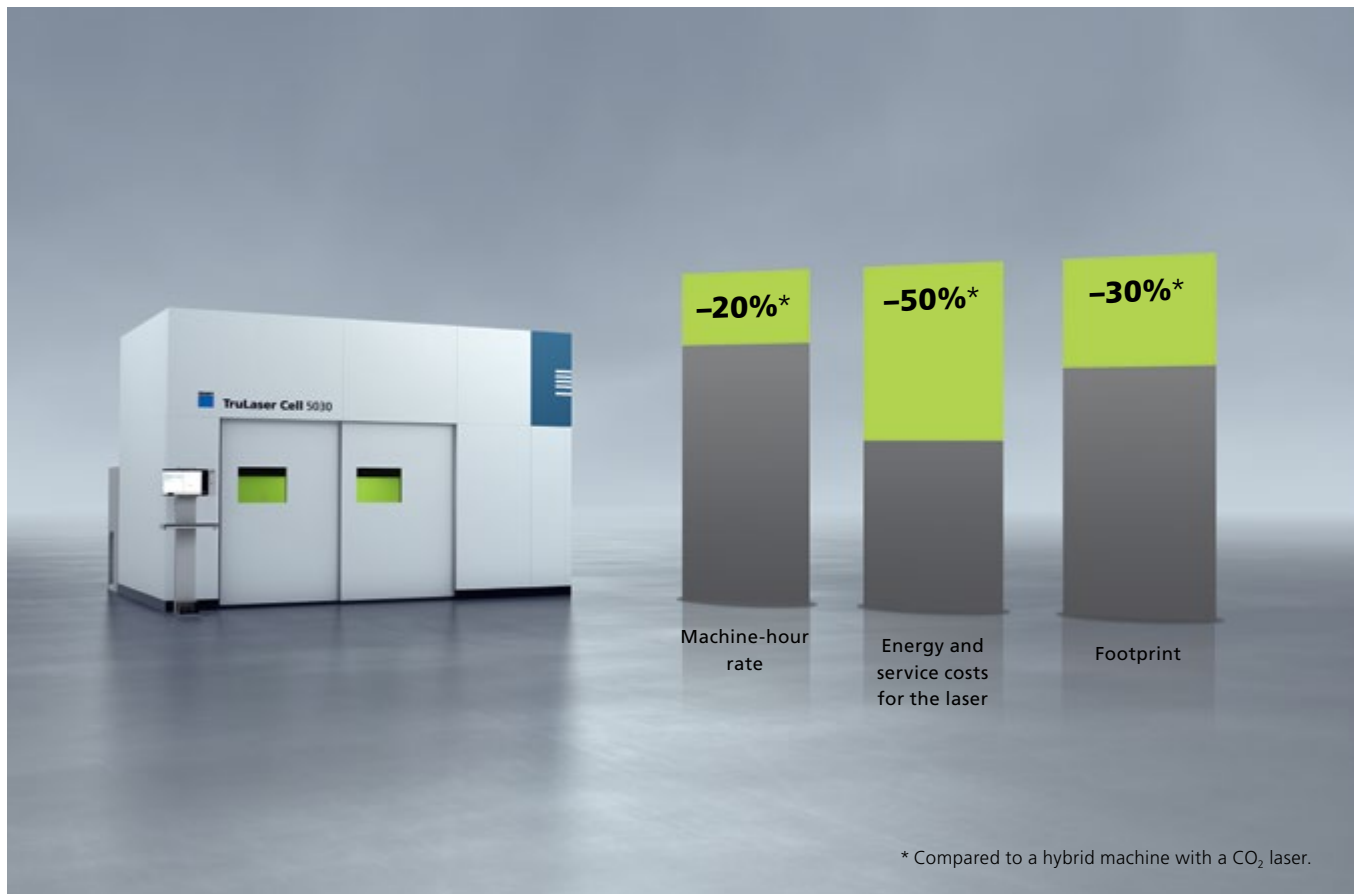

300% higher productivity, efficient solid-state laser and compact design – the TruLaser Cell 5030 offers great benefits compared to hybrid machines with a CO<sub>2</sub> laser.

# TruLaser Cell 5030 Hotforming Edition

The entry-level 3D laser cutting tool



01

## Low-cost introduction

to 3D laser cutting

02

## Manufacture more productively

in the midrange segment





03

## Saves space

thanks to compact installation area

04

## Diverse functions

for high processing dynamics  
and safety

05

## High process stability

thanks to the X-Blast nozzle



More information about  
the TruLaser Cell 5030  
Hotforming Edition can be  
found here:  
[www.trumpf.info/tupgfy](http://www.trumpf.info/tupgfy)

01

## Low-cost introduction

to 3D laser cutting

Would you like to get started with high-quality 3D laser cutting at an attractive price-performance ratio? Then our TruLaser Cell 5030 Hotforming Edition midrange system is exactly the right system for you! It incorporates a large number of the TruLaser Cell 8030 high-end machine's innovative functions, and is superior to comparable products on the market in terms of dynamics, functions and robustness.

03

## Saves space

thanks to compact installation area

Do you want to save space in your production environment? Then the TruLaser Cell 5030 Hotforming Edition is exactly the right cutting machine for you! Its design is not only compact, but also extremely user-friendly and ergonomic. The machine layout configuration is flexible so that the hall can be set up according to your requirements.



02

## Manufacture more productively

in the midrange segment

The TruLaser Cell 5030 Hotforming Edition is the ideal machine for applications with medium to high quantities that do not require the highest dynamics, e.g. bent tubes or profiles. Thanks to its good basic machine dynamics, the machine offers excellent performance – and at a good price-performance ratio. Combined with Dynamic Level 3, the machine accelerates even faster and can cut part times by up to 7%. Functions such as the rotary table ensure reduced non-productive times and process reliability.

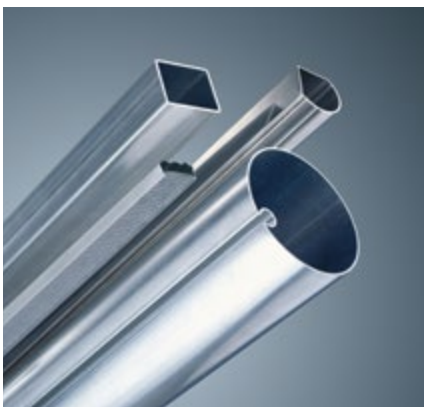

Production of up to 150,000 parts per year.

## 04

## Diverse functions

for high processing dynamics and safety

Functions such as FastLine Cell Basic or ObserveLine Comfort and Professional enable optimal production processes. FastLine Cell Basic (Fig. 1) improves and optimizes the approach behavior of the machine when piercing to cut the contour. Depending on the type of material and the material thickness, as well as the number of contours to be processed, you can increase the productivity of your system by up to 20%. Check in milliseconds whether a contour has been completely cut or whether cutting slugs are stuck in the component using the ObserveLine Comfort optical measuring procedure (Fig. 2). ObserveLine Professional (Fig. 3) verifies the positioning accuracy of the machine without any retrofitting and with almost no effect on the cycle time. Incorrect positioning is detected and the number of rejects is reduced. Produce faster, with less rejects and save costs in the process.



Figure 1: FastLine Cell Basic



Figure 2: ObserveLine Comfort

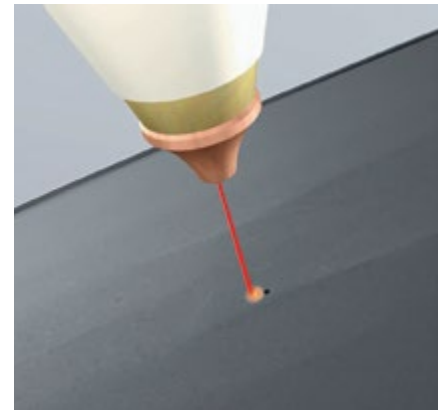

Figure 3: ObserveLine Professional

## 05

## High process stability

thanks to the X-Blast nozzle

Compared to conventional processes, X-Blast technology enables an unprecedented process range and the highest quality for 3D components. In addition, the working distance is significantly increased, thus minimizing the risk of nozzle collisions. You profit from higher part quality, lower consumable costs and increased productivity.

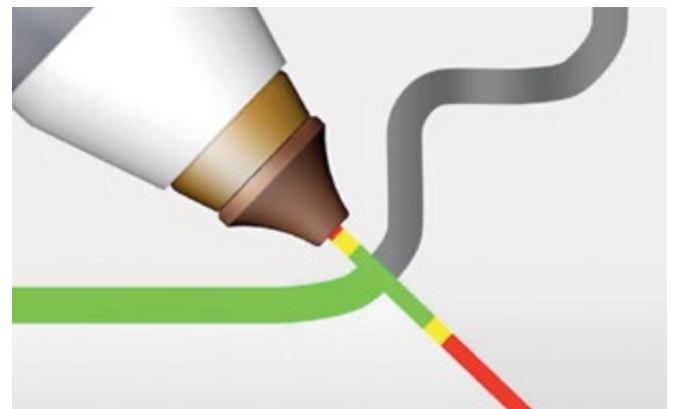
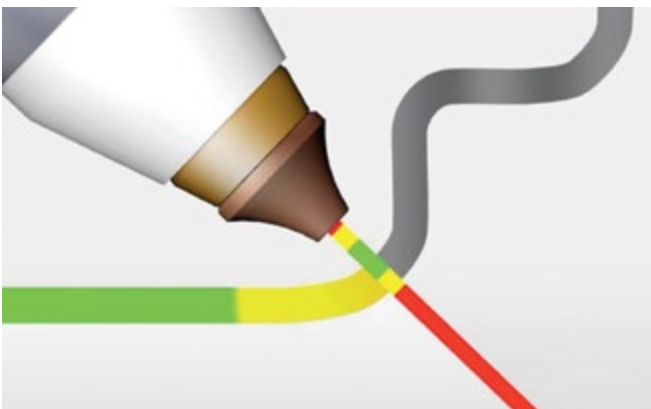

The greater distance between the cutting nozzle and the sheet metal reduces nozzle collisions and increases the quality of the 3D cutting edge.



# TruLaser Cell 7040

The perfectionist when it comes to 2D and 3D laser cutting and laser welding as well as laser metal deposition of large parts



01

## Unique flexibility

in 3D processing

02

## Top productivity

with frequently changing series and lot sizes

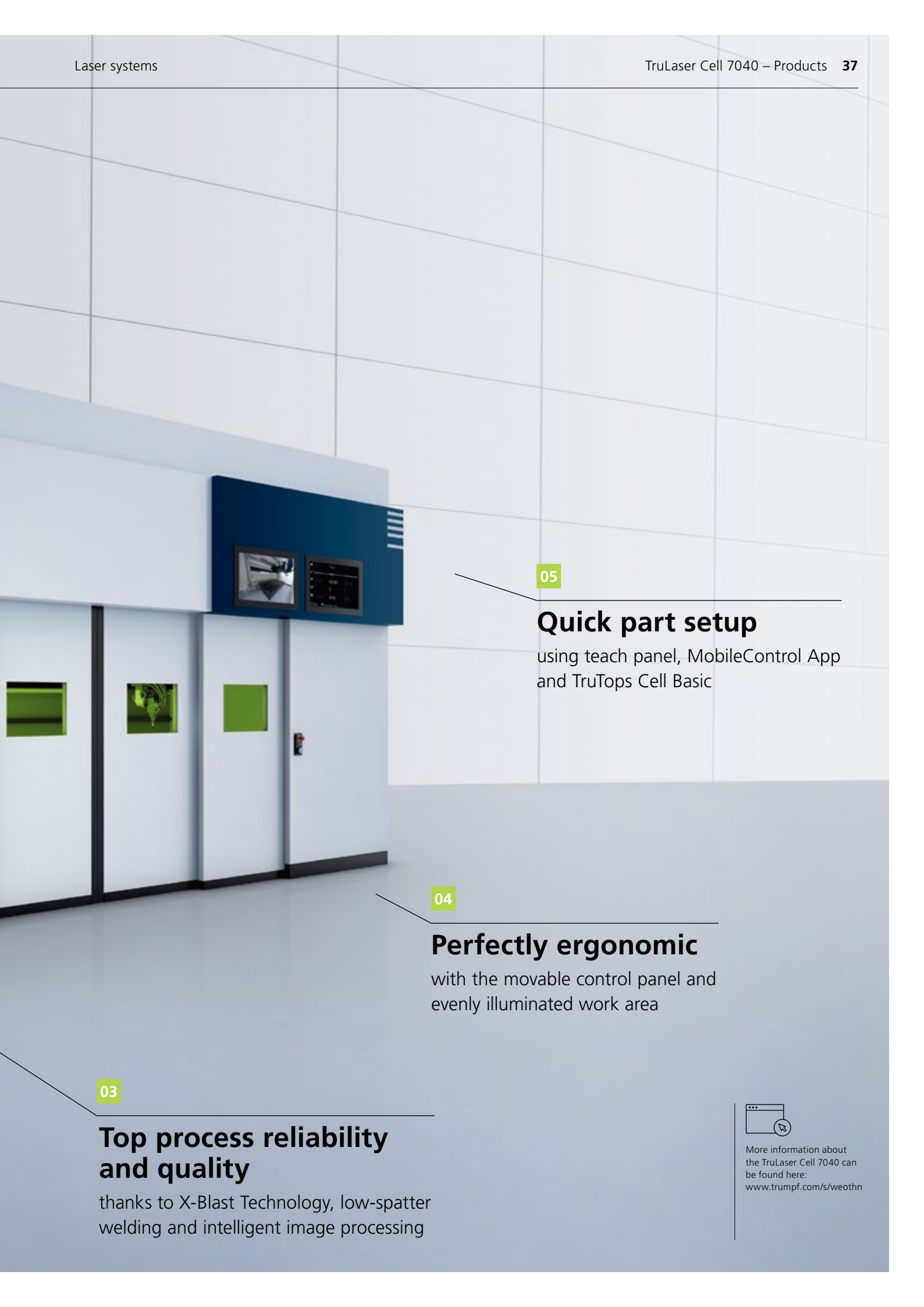

03

## Top process reliability and quality

thanks to X-Blast Technology, low-spatter welding and intelligent image processing

04

## Perfectly ergonomic

with the movable control panel and evenly illuminated work area

05

## Quick part setup

using teach panel, MobileControl App and TruTops Cell Basic



More information about the TruLaser Cell 7040 can be found here:  
[www.trumpf.com/s/weoethn](http://www.trumpf.com/s/weoethn)

01

## Unique flexibility

in 3D processing

The TruLaser Cell 7040 was specially developed for a flexible production environment. You can switch between 3D cutting and welding as well as laser metal deposition. The 2-in-1 LLK also automatically adjusts the laser beam optimally to suit the respective processing task. This means you are always perfectly equipped.



With the additional axis integrated in the optics, you can get perfect cutting results with high cutting speeds, even with complex 3D geometries. The X-Blast Technology makes the process extremely robust.



Perfect cutting results and high seam quality thanks to the almost spatter-free processing with BrightLine Weld, even at high processing speeds.



With laser metal deposition, three-dimensional parts can be coated, repaired or have their shape modified.

02

## Top productivity

with frequently changing series and lot sizes

High positioning speeds and axis dynamics allow for low production times. On-the-fly piercing with FastLine Cell reduces your nonproductive times by up to 40% when cutting. The front doors made of light GFRP material cut your time opening and closing doors by 35%. And you save even more time with loading and unloading parallel to production in 2-station operation and with an extremely fast rotary table which revolves the part into the work area in only 4 s. You manufacture more profitably than ever before, and that with absolute reliability.



You can load and unload parallel to production with the quick-turning rotary table. User-friendly component handling outside the machine is also possible. This saves money and time.

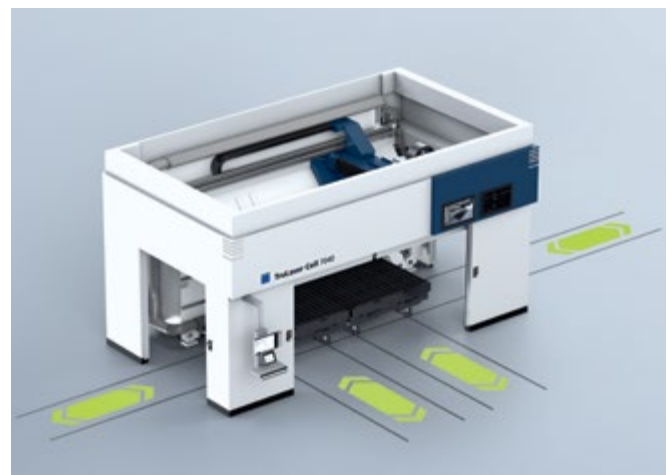

Quick setup with heavy components using tables which are movable in the X and Y directions.

03

## Top process reliability and quality

thanks to X-Blast Technology, low-spatter welding and intelligent image processing

The X-Blast nozzle technology ensures consistently good 3D cutting quality due to the greater nozzle-sheet distance. The ObserveLine sensor system inspects the cut contour at lightning speed. With the low-spatter welding provided by BrightLine Weld, outstanding weld seam quality and at the same time a tripling of the feed rate is achieved. Using the image processing feature VisionLine, you are always sure that the weld seam is placed at the right position. This noticeably increases the quality of your components, and saves time and money.

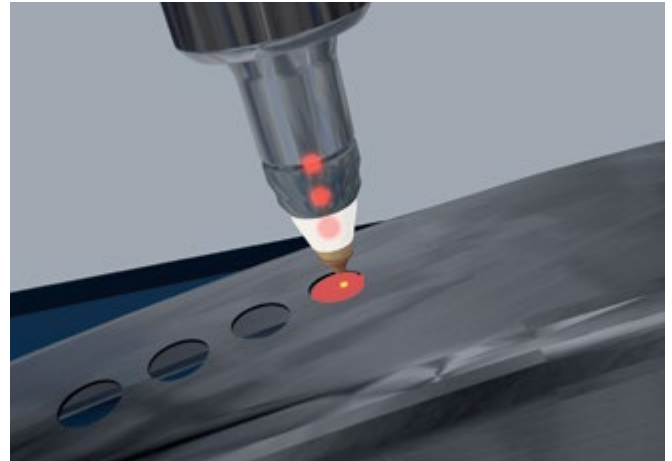

Patented ObserveLine testing system for automated inspection of cut contours.

04

## Perfectly ergonomic

with the movable control panel and evenly illuminated work area

The ergonomic control panel can be moved along the entire machine, ensuring a perfect view of the work area from every angle. The bright and optimally illuminated work area guarantees constant comfort while working. The Smart Optics Setup station also ensures that setting the optics is quick and reliable.



Smart Optics Setup ensures quick and reliable setting and adjustment work on the optics.

05

## Quick part setup

using teach panel, MobileControl App and TruTops Cell Basic

The compact teach panel with 6D mouse makes it easier to run in, teach and traverse the axes. With the TruTops Cell Basic software, the programs can be adapted directly at the machine – without making changes to the offline programming system. In addition, the control automatically detects which optics are installed, allowing for a quick and error-proof change of optics.



Quick program creation directly at the workpiece with the MobileControl App and teach panel.



# TruLaser Cell 8030

The expert in the 3D laser cutting of hot-formed parts



01

## Top productivity

in series production

02

## More efficient production

due to BrightLine Speed

03

## Clever functions

for high processing dynamics and safety

04

## Save space

due to the compact installation area



05

## Large components

processed efficiently

06

## Stable cutting process

with the X-Blast nozzle



You can find out even more about the TruLaser Cell 8030 here:  
[www.trumpf.com/s/uv1ld5](http://www.trumpf.com/s/uv1ld5)

01

## Top productivity

in series production

You process at maximum productivity with the TruLaser Cell 8030. Part times are reduced up to 7% using dynamic level 3. The numerous functions like, for example, the optimized rotary table, provide process reliability and shortened nonproductive times. The 20% reduced rotation time of 1.8 s is the fastest on the market. Intelligent automation solutions ensure that there are no bottlenecks, even with manual loading and unloading. You can optimize cycle times and achieve greater productivity using a rotary indexing table or a robot for part automation. With ObserveLine Comfort, the improved slug check is 4 times as fast as the competition.



The remaining time display lets you know at a glance how the component, and indeed the entire order, is progressing.

03

## Clever functions

for high processing dynamics and safety

Two optical measuring processes ensure greater reliability on the TruLaser Cell 8030: ObserveLine Comfort checks with lightning speed whether a contour has been fully cut out, thereby preventing cutting the cut-out scrap from remaining in the finished part. ObserveLine Professional monitors the positioning accuracy of the machine and can detect even the tiniest of positioning errors of the optics. The precise and secure magnetic coupling enables you to carry on working in no time at all, even in the event of a collision. With assistants like these, you save money by producing faster and reducing rejects.

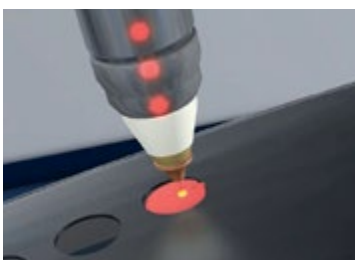

The ObserveLine Comfort measuring system ensures that every cutout is indeed cut out and gone.



The ObserveLine Professional measuring system monitors the correct positioning of the optics.

02

## More efficient production

due to BrightLine Speed

Thanks to new developments and optimized details, the TruLaser Cell 8030 offers you maximum productivity with minimal space. With our BrightLine Speed option, you increase productivity and process robustness in laser cutting, while significantly lowering gas consumption at the same time. You increase the cutting speed by up to 60% and reduce gas consumption by up to 50% at the same time. This boosts your competitiveness considerably – and all that with an improved carbon footprint.

### Hotforming with different lasers

TruLaser Cell 8030	CO <sub>2</sub> emission	TruLaser Cell 8030	CO <sub>2</sub> emission
+ 3000 W laser	100 t	+ 4000 W laser	106 t
		↗ + 20 % productivity	+ 6 %
TruLaser Cell 8030	CO <sub>2</sub> emission	TruLaser Cell 8030	CO <sub>2</sub> emission
+ 3000 W laser	93 t	+ 4000 W laser	106 t
+ BrightLine Speed	- 7 %	↗ + 20 % productivity	

More sustainable. Less CO<sub>2</sub>.

04

## Save space

due to the compact installation area

Lacking space in your production facility? No problem! The compact TruLaser Cell 8030 has a very small footprint, meaning you have the flexibility to plan multiple machines into your workspace according to your specific needs. A further advantage of the system is that it is ergonomic and extremely easy to use. The rotating changer can be loaded and unloaded from the front as well as the sides.



The compact, easy-to-use laser cell fits into any production line.

05

## Large components

processed efficiently

Produce large parts with top productivity. The working area of the TruLaser Cell 8030 can be extended as desired. With this concept, you can process door rings or other large hot-formed parts efficiently and completely.



You can even process very large hot-formed parts with the TruLaser Cell 8030.

06

## Stable cutting process

with the X-Blast nozzle

The optimized cutting nozzle processes at a greater clearance from the sheet – this reduces downtimes caused by nozzle collisions by 90%. Profit not just from the greater machine availability, but also from a 10% drop in nozzle wear and from optimal cutting edges, especially when tackling highly demanding 3D geometries.

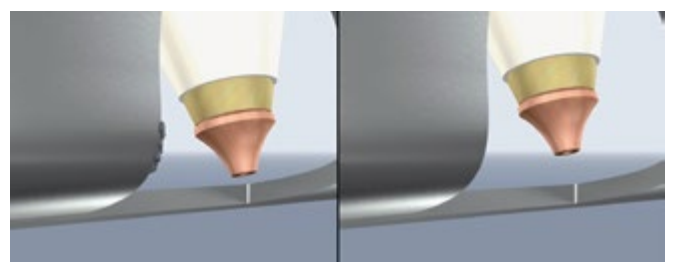
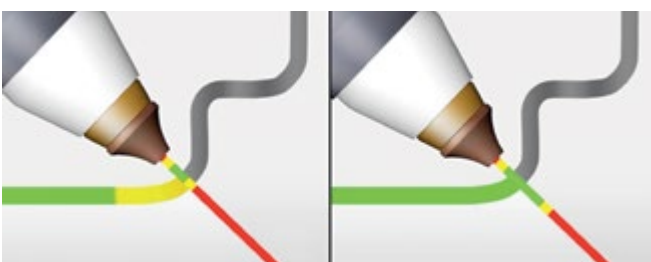

Even small radii can be cut with great quality with X-Blast thanks to a doubled processing spectrum.



# TruLaser Station 7000

The compact solution for the 3D laser welding  
of small parts



01

## Spacious work area on a minimized footprint

offering room even for larger components

02

## Profitable laser welding

thanks to the best price-  
performance ratio of its class

03

## Constant high part quality

with fully integrated  
image processing



06

## Optimal for complex welding geometries

thanks to its highly developed 3D processing technology

05

## High processing flexibility

guarantees a variety of welding applications

04

## Ideal for large quantities

because of the rotary table



You can find more information about the TruLaser Station 7000 here:  
[www.trumpf.com/s/trulaser-station-7000](http://www.trumpf.com/s/trulaser-station-7000)

01

## Spacious work area on a minimized footprint

offering room even for larger components

The TruLaser Station 7000 offers the ideal ratio of work area to installation area. A wide range of components can be processed in the machine's spacious work area – even large parts or complex fixtures.



The machine design has been optimized to provide the maximum work area despite its minimized footprint.

02

## Profitable laser welding

thanks to the best price-performance ratio of its class

The modular design of the TruLaser Station 7000 will keep your investment costs down. This modern machine concept is perfectly designed for welding assemblies such as sensor systems, rotationally symmetrical parts and medical instruments. You will also be impressed by the low cost per part.



Welding seams on a power sensor module.

03

## Constant high part quality

with fully integrated image processing

The integrated image processing feature detects component geometries. This means that you always weld at the right point and save time and money as you produce with unchanging high quality. The intuitive user interface takes the operator quickly through the individual work steps on the spacious touchscreen.



The height and angle of the ergonomic operating panel can be freely adjusted to the operator's preference. It can be positioned left or right of the machine.

04

## Ideal for large quantities

because of the rotary table

Automate easily with the TruLaser Station 7000: The rotary table with 2 stations allows you to produce and set up at the same time. This is particularly recommended for high quantities. It is possible to load and unload your parts with a robot.



The 2 stations of the rotary table make loading possible even when the machine is operating. With this, you maximize your productivity.

05

## High processing flexibility

guarantees a variety of welding applications

Weld very diverse seam geometries at a constantly high level of quality. No matter whether you are using heat conduction or deep penetration welding, whether it's with thin or thick sheet – the TruLaser Station 7000 offers high performance. You can choose between swiveling welding optics and scanner optics and select among a wide variety of beam sources.



Whether you want to weld electrical contacts for control units, medical instruments or ultrasonic sensors – the TruLaser Station 7000 can be adapted to your requirements.

06

## Optimal for complex welding geometries

thanks to its highly developed 3D processing technology

With up to 5 interpolating axes you can handle complex 3D components and seam geometries without any problem. The corresponding fixture equipment can be accommodated in the spacious working area and can be programmed using a traveling operator interface.



3D laser welding in the medical technology field.



# TruLaser 8000 Coil Edition

The diversity of variants is growing, the production volumes are smaller: This is precisely where the TruLaser 8000 Coil Edition from TRUMPF comes in. Laser processing directly from the coil saves time, costs and material and enables cost-effective laser cutting from small to large series.

06

## Efficient scrap disposal

by means of separating cuts in the scrap skeleton, including scrap removal

05

## Automated unloading

thanks to the fully integrated robot and gripper system

04

## Increased productivity and flexibility

thanks to the TruLaser cutting system and newly developed conveyor belt

03

## Continuous straightening process

ensures the highest surface and component quality





02

## Highest cutting quality

thanks to a high-quality straightening process

01

## Increased cost-efficiency

thanks to continuous material supply and short set-up times



01

## Increased cost-efficiency

thanks to continuous material supply and short set-up times

Save up to 15% on costs compared to sheet goods when procuring the material. At the same time, you benefit from up to 15% more material utilization thanks to more efficient nesting. Whether steel, stainless steel or aluminum – many different materials can be processed.



Coils of up to 25 t can be picked up.

02

## Highest cutting quality

thanks to a high-quality straightening process

The precision leveler delivers consistently flat and low-tension material. Coil material with a thickness of 0.5 to 4 mm (optionally up to 6 mm) can thus be cut reliably.



Even higher-strength steels can be processed with straightener technology.

03

## Continuous straightening process

ensures the highest surface and component quality

The belt speed in the conveyor system is accelerated depending on the process and is never stopped. By decoupling the cutting process from the material feed, the risk of surface damage caused by the straightening process is avoided.



Feed drive rolls transport the material into the laser cutting cell at the highest conveying speed.

04

## Increased productivity and flexibility

thanks to the TruLaser cutting system and newly developed conveyor belt

With the TruLaser 8000 Coil Edition, you can fully automate the cutting process. By transporting the coil material linearly through the machines, non-productive times can be cut many times over compared to conventional laser cutting systems. While the new material is being transported in, the cut contours (including scrap skeleton) come out while the scrap material is unloaded. This significantly increases the productivity of the entire system.

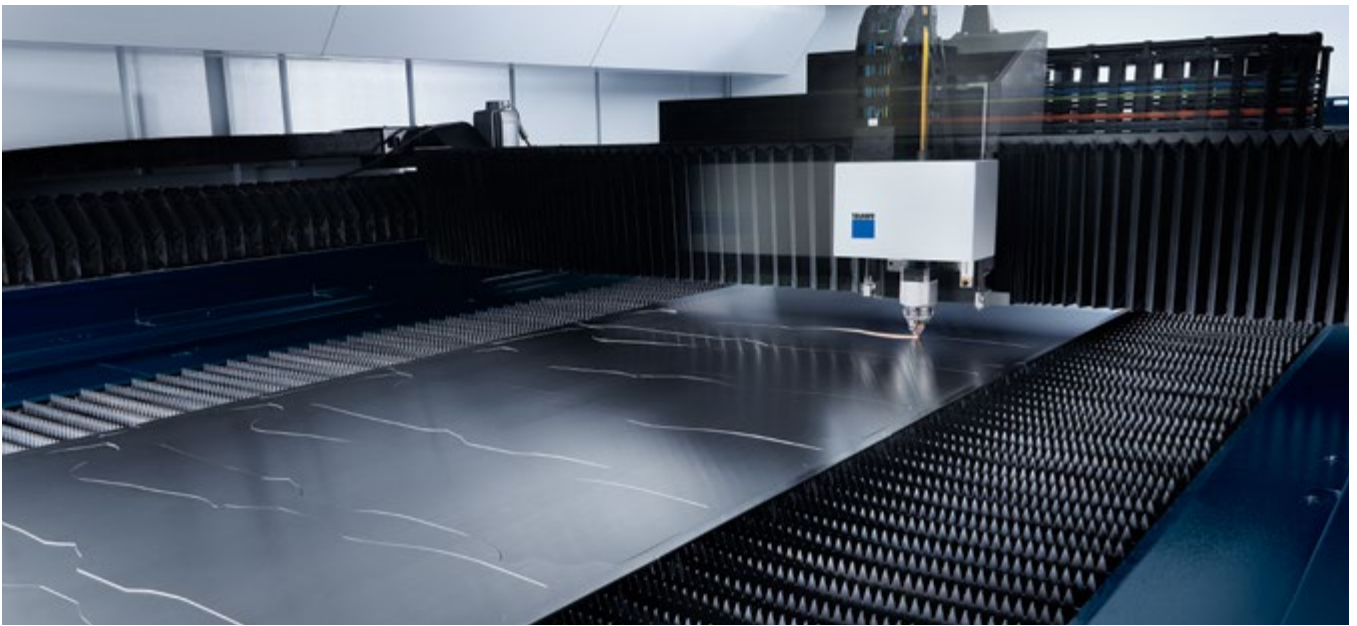

Simultaneous material transport into the machine and removal of processed material including scrap material.

05

## Automated unloading

thanks to the fully integrated robot and gripper system

Robots enable unloading during productive time and repeatable stacking. The complete integration of the robot kinematics into the control architecture eliminates the need for robot-specific programming expertise.



The highly productive laser blanking system can be flexibly connected to storage systems.

06

## Efficient scrap disposal

by means of separating cuts in the scrap skeleton, including scrap removal

Thanks to freely programmable separating cuts, the scrap skeleton breaks down into smaller parts during removal and can be disposed of cost-effectively. Integration into the customer's scrap logistics is facilitated by the variable scrap conveyor belt.



Small separating cuts are already made in the scrap skeleton during the cutting process.



# TruMark Stations

Turnkey laser marking solutions



**TruMark  
Station 5000**

**TruMark  
Station 3000**

- Components in a range of sizes and weights
- Desktop and stand-alone units
- High level of productivity and automation
- Simple operation
- Infrared, green and UV lasers available
- Can be expanded with options including image processing, rotary axes and other handling systems



[www.trumpf.com/s/productfinder-1](http://www.trumpf.com/s/productfinder-1)



**TruMark  
Station 7000**

**TruMark  
Station 7000 with  
rotary changer**



Further information  
on the marking systems  
can be found here:  
[www.trumpf.com/s/marketing-systems](http://www.trumpf.com/s/marketing-systems)

# TruMark Station 7000 and 7000 with rotary changer

## Marking of large and heavy components

The TruMark Station 7000 marking system offers plenty of space for your workpieces and devices with its large interior dimensions. It is possible to mark both individual large as well as heavy components, or a large number of smaller parts alongside each other and process them automatically.



## Perfect marking results thanks to a large range of lasers

Lasers with different power classes, wavelengths and pulse durations are available for the TruMark Station 7000. Furthermore, additional options such as a rotary table, focusing lenses, camera systems, and lighting provide additional flexibility. For example, rotationally symmetrical workpieces can be fully processed using swivel mechanisms and rotary axes.



## Batch production specialist

The TruMark Station 7000 can be easily integrated into efficient batch production. Automatic loading and unloading and a connection to a storage system provide an additional boost in productivity. The station is ideal for handling large lot sizes – especially the variation with the rotary table option. The components are brought to the machining area and processed using a rotary plate. The machine can already be reloaded with components during the machining process.



# TruMark Station 5000

---

## Universal solution

---

A number of lasers with different focusing lenses, focal lengths and wavelengths are available for the TruMark Station 5000.



---

## Ready to use anywhere – in your flow line or as a stand-alone workstation

---

Benefit from our unbeatable combination of a larger working range plus a compact design. The TruMark Station 5000 is ideally suited for use in your flow line. Or set it up as a stand-alone workstation. Standing up or sitting down? Thanks to the intelligent ergonomic design, it is up to you!

---

## Flexible integration

---

The TruMark Station 5000 makes life easy for you: You can easily integrate it into your flow line thanks to the housing's side openings for the flow-through transfer of workpieces. Or why not opt for the TruMark Station 5000 without any housing (laser class 4) for processing larger components? You also have the option to expand the sealed work area on both sides.





# TruMark Station 3000



TruMark Station 3000.

## Perfectly equipped

The TruMark Station 3000 is perfectly suited to customers with small and medium lot sizes. An optional rotary axis increases the marking station's flexibility. And if you want to switch to batch production, simply remove the side flaps and feed your production line through.

## Compact desktop application

Equipped with a TruMark One-Box laser, the TruMark Station 3000 will even fit onto your desk thanks to its compact outside dimensions.

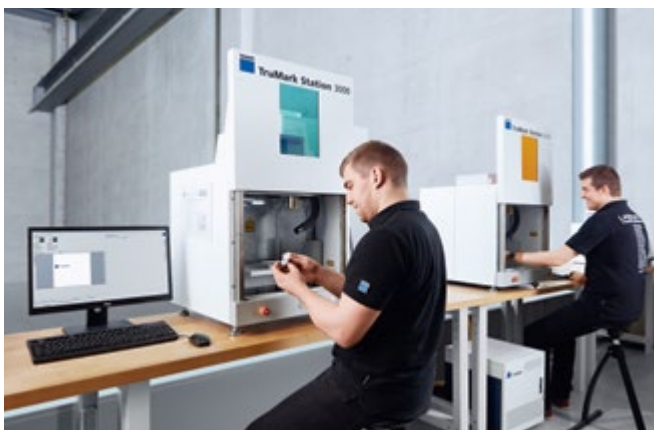

## A comfortable way to work

The TruMark Station 3000's operating elements feature an ergonomic layout, and the system is controlled using the tried-and-tested TruTops Mark marking software. An automatic door ensures quick and convenient loading and unloading. A motorized Z axis also supports the positioning of the components and the setting of the exact focus position.



# VisionLine image processing

## Always in focus

Save time and money and still get maximum marking quality

The distance measurement function<sup>[1]</sup> provides support when setting the working distance. The objective of the on-axis camera can be focused on any position in the marking area on which the laser is concentrating. Focusing of the processing beam and the camera are independent of each other.



<sup>[1]</sup> Distance measurement function in the center of the marking field. Automatic distance correction only in combination with the TruMark Station 5000 or 7000.

## Modular setup

Optimal adjustment for every application situation

Assemble the right package from the VisionLine product series – consisting of Adjust, Detect, Model, Code and OCR – that is tailor-made to the requirements of your actual application. The hardware is always included: One camera is aimed through the scanner lens (on-axis), a second one is laterally aimed at the marking field (off-axis). The on-axis camera can find the correct marking position on the component. Thanks to the stitching function – which strings images together – you can even keep an eye on large components. The off-axis camera reduces the process time, as the entire marking field is captured in one camera image, making stitching unnecessary. There is also the option of selecting lighting – in the wavelength suitable for the respective marking laser.



You can find further information here:  
[www.trumpf.com/s/image-processing](http://www.trumpf.com/s/image-processing)

# TruTops Mark 3D

## Intuitive handling

Full-featured 3D CAD software

2D and 3D marking with TRUMPF marking lasers has never been so quick and easy: Our TruTops Mark 3D marking software features impressive user-friendly operation and significantly shorter processing times. Depending on the application, it is now possible to mark multiple objects with a single laser system – where in the past several lasers would have been required. This saves you money while increasing flexibility. The newly developed wrap algorithms from TRUMPF guarantee that the marking is undistorted and aesthetically pleasing.

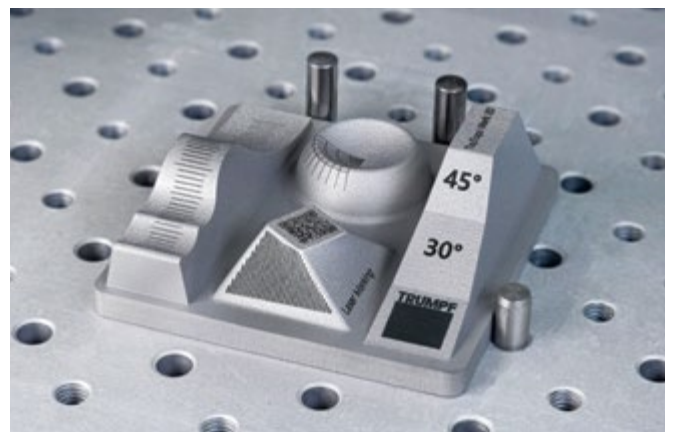

You can find further information here:  
[www.trumpf.com/s/trutopsmark-3D](http://www.trumpf.com/s/trutopsmark-3D)

# The right solution for every metal AM application

From prototype manufacturing to industrial serial production



## Our additive production systems for metal powder

As a pioneer in additive technologies and a specialist in lasers, we offer the perfect technology for any application requirement: be it laser metal fusion (LMF/LPBF) or laser metal deposition (LMD). Benefit from industrial solutions with intelligent monitoring and smart services around the world. Still on the lookout for an application that you'd like to produce using additive manufacturing? Speak to our consultants for newcomers to the world of AM.



**Sounds interesting? Then visit our  
AM showroom – either in person or virtually.**

[www.trumpf.info/am-showroom](http://www.trumpf.info/am-showroom)



Find out more about our extensive additive manufacturing product portfolio at: [www.trumpf.com/s/additivemanufacturing](http://www.trumpf.com/s/additivemanufacturing)



# TruServices. Your Partner in Performance

For a successful future, choose services that will help you progress in the long term: Whether you want to create the best conditions for successful manufacturing, make the most of your TRUMPF laser systems, or have the flexibility to adapt them to changing requirements – together we will find opportunities to maximize your value creation long-term. We will provide you with all-round support as a reliable partner with solutions and service packages for your needs – enabling you to manufacture economically and at a constantly high level.

## EMPOWER

**If you want to create the best conditions for successful production, we will support you in this.**



### **Training – reach your full potential with professional development**

If you are well trained, you can fully utilize the potential of your lasers, laser systems, machines and software, and secure key competitive advantages. In the laser cutting technology course, for example, you learn how to obtain the best possible cutting quality and determine piercing parameters for special materials.

## SUPPORT

**If flexibility and availability of equipment in day-to-day operations are essential to you, we can help.**



### **Service app – the app for your service messages**

Whether it's a technical problem, software, a spare part or a question concerning maintenance: with the Service app and your free MyTRUMPF account, you can send your service messages quickly and easily to our Technical Service team at any time.

## IMPROVE

**If you want to gradually focus your production on maximum value creation, we can help you achieve your goal.**











### **Service agreements – get just the service you need**

Where system maintenance and servicing are concerned, you will benefit from expert support of the highest quality. Ensure constant maximum machine availability, consistently high production quality, and low operating costs with service agreements from TRUMPF.





 Financing	 Training	 Technical Service	 Genuine parts	 Tools	 Service agreements
 Software	 Process optimization	 Monitoring & analysis	 Product enhancements	 Pre-owned machines	



You can learn more about our complete and comprehensive package of useful services here: [www.trumpf.com/s/services](http://www.trumpf.com/s/services)



# Technical Data

TruLaser Station 7000  
TruLaser Cell 3000, 5030, 5030 Hotforming Edition, 7040, 8030

Technical data			
		TruLaser Station 7000	TruLaser Cell 3000
<b>Axis travel range</b>			
X	mm	650	800
Y	mm	350	600
Z	mm	500	400 (+300) <sup>[1]</sup>
B/C <sup>[2]</sup>	°	± 120/n × 360	± 135/n × 360
Max. load	kg	50	400
<b>Speed</b>			
X/Y/Z	m/min	6	50
Simultaneous	m/min	10	85
B/C <sup>[3]</sup>	1/min	15/200	120/400
<b>Acceleration</b>			
X/Y/Z	m/s	1	10
B/C <sup>[3]</sup>	rad/s	63/157	125/500
<b>Positioning accuracy</b>			
Linear axes X/Y/Z	mm	0.08	0.015
Rotary axes B/C <sup>[3]</sup>	°	0.2	0.02/0.02
<b>Repeatability</b>			
Linear axes X/Y/Z	mm	0.03	0.02
Rotary axes B/C <sup>[3]</sup>	°	0.06	0.006/0.02
<b>Laser</b>			
Max. Laser power	W	2000 <sup>[4]</sup>	8000 <sup>[4]</sup>
Available lasers		TruDisk, TruPulse, TruDiode, TruFiber, TruMicro <sup>[2]</sup>	TruDisk, TruDiode, TruFiber
Available technologies		Laser welding	Laser welding, laser cutting, laser metal deposition
<b>Rotary table</b>			
Diameter	mm	770	1070
Max. load per side	kg	35	95
Stations	Quantity	2	2
Rotation time	s	3.5	3
Total typical non-productive time	s	7.2	5.2

<sup>[1]</sup>With additional W1 axis. <sup>[2]</sup>Fiber-guided. <sup>[3]</sup>Rotary axis C180. <sup>[4]</sup>Higher laser power on request.

<sup>[5]</sup>Dimensions are specified in the standard layout of the customer-specific system. <sup>[6]</sup>Applies to large variants.

Subject to change without notice. Only specifications in our offer and order confirmation are binding.

## Find out more at [www.trumpf.com](http://www.trumpf.com)

- Technical data sheets available to download
- Clear comparison of up to three products
- Display configured to suit all devices

TruLaser Cell 5030	TruLaser Cell 5030 Hotforming Edition	TruLaser Cell 7040	TruLaser Cell 8030
3000 (+ 300)	3300	4000	3000
1500	1500	1500/2000	1300/2100 <sup>[6]</sup>
700	600	750/1000	600/650 <sup>[6]</sup>
± 135/n × 360	± 135/n × 360	± 135/n × 360	± 135/n × 360
250 (3D work table), 800 (2D/3D work table)	300	1600	300 (700 <sup>[6]</sup> )
60	60	100	100
104	104	173	173
60	60	90/90	90/90
5	9.5	9/10/10	11 (10 <sup>[6]</sup> )
200/100	200/100	200/100	200/100
0.08	0.08	0.08	0.08
0.015	0.015	0.015	0.015
0.03	0.03	0.03	0.03
0.005	0.005	0.005	0.005
4000	3000–4000	6000	4000
TruDisk, TruFiber P	TruFiber P	TruDisk	TruDisk, TruFiber P
Laser welding, laser cutting	Laser welding, laser cutting	Laser welding, laser cutting, laser metal deposition	Laser cutting
	4000	4600 (5400 <sup>[6]</sup> )	4000 (5000 <sup>[6]</sup> )
	300	750/1000	300 (700 <sup>[6]</sup> )
	2	2	2
	2.5	3	1.8 (3.0 <sup>[6]</sup> )
	4.8	6	3.7 (4.9 <sup>[6]</sup> )



# Technical data

## TruLaser 8000 Coil Edition

Technical data		
		<b>TruLaser 8000 Coil Edition</b>
<b>Axis travel range laser cutting cell with TruDisk 8001</b>		
X axis	mm	4000
Y axis	mm	2500
Z axis	mm	116
<b>Coil system</b>		
Coil outer diameter	mm	800 to 2000
Coil inner diameter	mm	508   610
Coil width	mm	1650   2150
Carrying capacity of coiler	t	20   25
<b>Robot unloading</b>		
Number of axes		6
Max. carrying capacity	kg	220
Maximum horizontal range	mm	2701
Repeatability	mm	0.08
<b>Standard change gripper system</b>		
Number of suction cups	Quantity	48
Minimum part size	mm	300 x 200
Maximum component size	mm	2500 x 1250
Maximum part weight	kg	100
<b>Options</b>		
Cleaning station		Yes
Coil width up to 2150 mm		Yes
Carrying capacity of coiler up to 25 t		Yes
Cutting/cropping shears		Yes
Second unloading robot		Yes
Customized gripper system		Yes
Storage connection		Yes
<b>Upon request</b>		
Alignment technology with 17/21 rollers		Yes

Content subject to change without notice. Only specifications in our offer and order confirmation are binding.

## More information on [www.trumpf.com](http://www.trumpf.com)

- Technical data sheets available to download
- Clear comparison of up to three products
- Display configured to suit all devices

### TruLaser Cell 1100

Technical data		
		TruLaser Cell 1100
<b>Axis travel range</b>		
X	mm	300 × 500
Z	mm	300 × 500
Q	mm	± 25
X/Z positioning accuracy	mm	± 0.1
Q positioning accuracy	mm	± 0.05
Max. Laser power	W	15000
Available lasers		TruFlow, TruDisk, TruDiode

Content subject to change without notice. Only specifications in our offer and order confirmation are binding.

### TruMark Station 3000, 5000, 7000 and 7000 with rotary changer

Technical data					
		TruMark Station 3000	TruMark Station 5000	TruMark Station 7000	TruMark Station 7000 with rotary changer
<b>Available marking lasers</b>		TruMark 1110, 3330, 5010, 6030	TruMark 3230, 3330, 5010, 5020, 5050, 6030	TruMark 3330, 5050, 6030, 7050, TruMicro Mark 1020, 2030	TruMark 3330, 5050, 6030
Work station dimensions (W × D × H)	mm	625 × 730 × 672/1092 <sup>1)</sup>	860 × 1312 × 2010/2310 <sup>1)</sup>	1150 × 1420 × 2000 / 2556 <sup>1)</sup>	1150 × 1624 × 2000 / 2524 <sup>1)</sup>
Weight (without laser, supply unit)	kg	82	480	1250	1400
Electrical connection (voltage)	V	120/230	120/230	120/230	120/230
Electrical connection (frequency)	Hz	50/60	50/60	50/60	50/60
Electrical connection (amperage)	A	16 at 230 V 20 at 120 V	16 at 230 V 20 at 120 V	16 at 230 V 20 at 120 V	16 at 230 V 20 at 120 V
Max. workpiece dimensions (W × D × H)	mm	450 × 350 × 200	384 × 375 × 500	960 × 375 × 500	Rotary plate Ø 770 mm
Max. Workpiece weight	kg	12	50/25 (with X/Y axis)	75/50 (with Y axis)	35 per side
Available axes		Z	X   Y   Z	X   Y   Z	X   Z
Max. Traverse path	mm	200	300   300   500	650   350   500	650   500
Rotary axis	mm	65	65, 150	125	125
Suction system		Built-in, external fitting is possible	Built-in, external fitting is possible	Built-in, external fitting is possible	Built-in, external fitting is possible

<sup>1)</sup> Height of the machine with open lifting door.

Content subject to change without notice. Only specifications in our offer and order confirmation are binding.

# Passion is what drives us

Whether it's production and manufacturing technology, laser technology, or material processing – we develop highly innovative products and services for you which are tailored to your industry and which are absolutely proven and reliable. We put everything we've got into giving you a compelling, competitive edge: expertise, experience, and above all passion.



Check out our  
YouTube channel:  
[www.youtube.com/  
@TRUMPFtube](http://www.youtube.com/@TRUMPFtube)



## Solutions for your future

With a step-by-step introduction to your Smart Factory, you can take advantage of digital networking opportunities. We partner with you on the path to networked production, delivering pragmatic, economical solutions that make your processes both more transparent and flexible.

This will allow you to maximize your resources while ensuring your production is fit for the future. We support you every step of the way until your production runs perfectly for your needs.

## Machines & systems

Laser cutting in 2D and 3D, punching, bending, laser welding and punch laser processing: With custom-fit machine tools, laser systems, software, and automation from TRUMPF, you can master flexible sheet metal and tube processing. Additive manufacturing solutions round off our portfolio – a portfolio that includes consulting, software, and services.

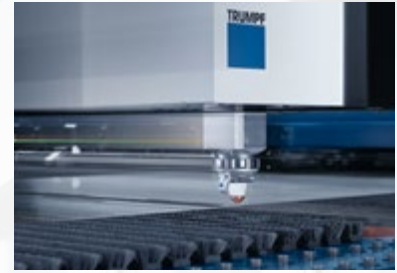

## Lasers

Whether for cutting, welding, marking or processing surfaces, with lasers from TRUMPF you have the universal tool for your industrial applications. Choose the ideal system solution for you from the macro, micro and nano ranges. We will also support you with software solutions, application knowledge and consulting.



## VCSEL solutions & photodiodes

Laser and photodiodes from TRUMPF Photonic Components come into their own in numerous applications: in the industrial and consumer markets and even in optical data communication. A VCSEL (Vertical Cavity Surface Emitting Laser) laser diode emits light perpendicular to the plane of the semiconductor chip. In the TruHeat VCSEL systems, millions of VCSELs generate infrared heat, which is used for laser heat treatment.

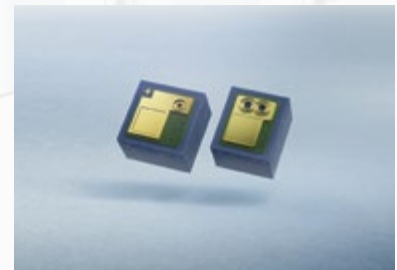

## Power electronics

Nothing's hi-tech without a process power supply: With generators for plasma technology, industrial heating, battery inverter systems and microwave amplifiers, you get power at the frequency and performance you need. These technologies can be found in smartphones, for example, on glass facades, in PV systems or in microchips.



## Power tools

Whether for cutting, connecting, and edge forming of sheet metal, professionals all over the world rely on the user-friendly electric and battery-powered tools from TRUMPF. On construction sites and in workshops, the quality products manufactured in Switzerland convince, gain and retain fans with their modern technology and perfect handling.





TRUMPF is certified to ISO 9001  
(Find out more: [www.trumpf.com/s/quality](http://www.trumpf.com/s/quality))

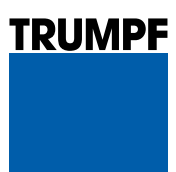

TRUMPF Laser- und Systemtechnik GmbH  
[www.trumpf.com](http://www.trumpf.com)